



# NAVY NEWS

MAY 2014

## A GREAT CRUSADE

**SPECIAL  
D-DAY 70  
PULL-OUT**



# ULTIMATE SAFEGUARD

● Heavily-armed patrol boat HMS Tracker shepherds the Navy's ultimate weapon, ballistic missile submarine HMS Vigilant, home to Faslane after her deterrent deployment.

Picture: CPO(Phot) Tam Macdonald, FRPU North



Off-sale date: May 31, 2014

£2.80



# Warriors unit



**A** Merlin Mk 2 from 820 Naval Air Squadron meets up with HMS Torbay during an anti-submarine warfare exercise off Scotland as part of the first Exercise Joint Warrior of 2014.

Merlins took part in the largest naval war game of the year in European waters, involving 33 ships, three submarines, 48 fixed-wing aircraft, 40 rotary wing aircraft and 13,584 personnel from nine nations.

820 NAS embarked three of their Merlins to HMS Illustrious to see how versatile their home on the Navy's Commando Helicopter Carrier has become, since the squadron last operated with the Response Force Task Group.

"It's a different set up on board than we've traditionally been used to," said Lt Cdr Neil Parrock, 820 NAS Senior Pilot.

"With Merlin Mk2's, 'Jungle' Sea Kings and Chinook helicopters on 'Lusty' the dynamics are quite exciting - we're meeting old friends and making new ones as we go along.

"The Chinooks take up a large part of the deck and it's like a Chinese puzzle when shifting aircraft, but everyone's benefiting from the challenge."

The Merlins were countering the submarine threat which the exercise planners included in the form of boats set to attack the naval force.

Lt Cdr Parrock added: "As we receive more and more tasking from the Commander UK Task Group, screening operations from hostile sub-

surface and surface threats to the task group, the Merlin 2 is proving itself more than capable."

The Merlin Force from Royal Naval Air Station Culdrose is preparing for a longer stay on HMS Illustrious for Exercise Deep Blue next month, which will see the Merlin helicopters once again embarking.

That exercise is set to practise larger screening operations and dedicated anti-submarine warfare tactics.

Joint Warrior saw elements of the Army and RAF working alongside Royal Navy ships including the Fleet Flagship HMS Bulwark, HMS Illustrious, frigates, destroyers and minehunters in the (mostly miserable) Scottish weather.

The exercise - which aims to test the high-readiness of the forces involved - saw a number of evolving crises and conflict scenarios featuring multiple nations, internal disputes, piracy and terrorist activities.

Run over three weeks, the exercise saw the development of simulated political and military tension in a fictional nation resulting in hostilities; Royal Marines were sent ashore to secure areas with commandos from the Netherlands and Belgium, while personnel from HMS Bulwark led an exercise to safely evacuate British passport-holders from the troubled country.

The exercise began in dramatic fashion as Royal Marines of Plymouth-based 3 Commando Brigade and Taunton's 40 Commando attacked a 'rebel' stronghold.

Beginning with an assault on three designated points on Luce Bay, south

of Stranraer, around 1,000 marines arrived by landing craft and helicopters in the early hours.

As part of the scenario, Castle Kennedy airfield had been captured by enemies of the fictional government - and it was the job of the Royal Marines to take it back.

Belgian and Dutch marines in HNLMS Johan De Witt opened a path from the sea on to the beaches, after which the Royal Marines were launched from Plymouth-based HMS Bulwark and Portsmouth-based HMS Illustrious, as well as auxiliary RFA Lyme Bay.

Pushing their way forward under the cover of darkness on foot and in vehicles, the men of 3 Commando faced heavy resistance from the 'enemy', played by their colleagues.

Using night vision goggles they assembled themselves in key positions and fired smoke grenades, blank rounds and dummy grenades to simulate how they would force a real surrender.

By mid-morning, the WW2 airfield was secured, while the 'Low Country' marines continued to bring their vehicles and personnel ashore at Craignarget to start preparing for the next phase.

Mne Jack Ginger, from Chorley in Lancashire, a member of 40 Commando, based at Norton Manor, said: "It's good to get out and practise these skills, plus it's good fun."

During the exercise the Royal Marines of 3 Commando Brigade continued their drive to recapture key areas, culminating with a final assault on the last 'rebel' position in the ruins

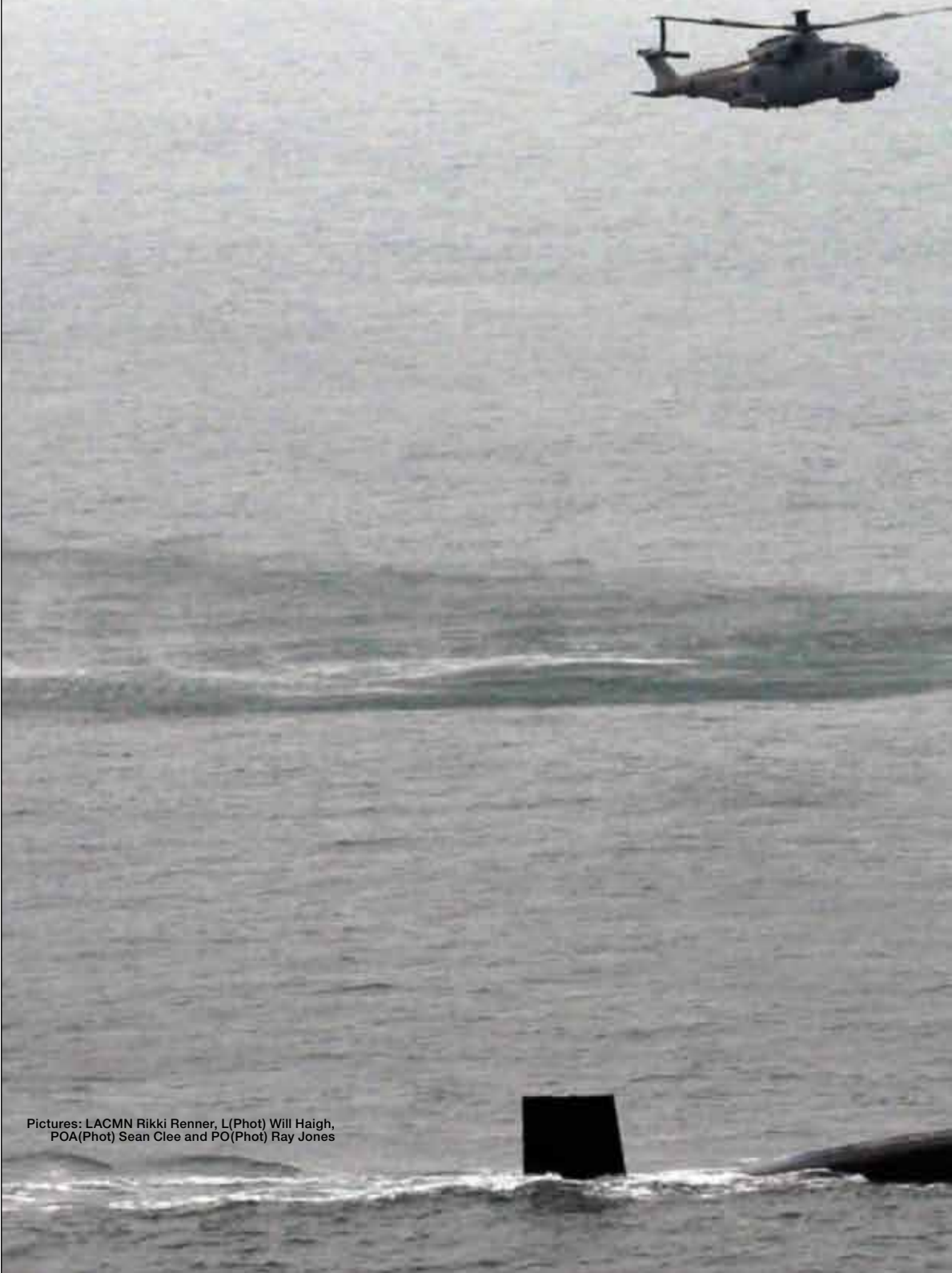

Pictures: LACMN Rikki Renner, L(Phot) Will Haigh, POA(Phot) Sean Clew and PO(Phot) Ray Jones



# ted for war games

All in a normal day's work...

## Bulwark – not just an assault ship

Having led Exercise Joint Warrior HMS Bulwark (right) will be the focus of the Royal Marines 350th anniversary celebrations in London later this month when she will spend six days anchored off Greenwich.

The programme will include 'whizzbangy' demonstrations, a RM350 reception combined with the annual Peregrine Trophy Awards, as well as hosting VIPs and open days for the public.

Bulwark will then depart for Portsmouth where she will provide the backdrop for a series of events marking the 70th anniversary of D-Day in June.

Royal Marines will land ashore next to the Hovercraft terminal, in view of the activities on Southsea Common.

Next Bulwark will lead a convoy of frigates, destroyers and other ships to Normandy. Arramanches will be the focus of UK commemorations on June 6 and the following day Bulwark will be off Port-en-Bessin, the port liberated by 47 Commando following their landing at Gold Beach.

Memorial services will be held at either side of the port, with both Royal Navy and Royal Marines personnel taking part.

Bulwark then returns to Plymouth to prepare to again lead the Navy's key task group deployment, Cougar 14, later in the year. Throughout this time Bulwark, as Flagship, is home to the UK's Response Force Task Group and is held at very high readiness to respond to any world event.



"The ultimate challenge is the wide-ranging programme we have," admitted CO Capt Dean Bassett. "We have maintenance and at the same time we have to maintain operational capability. Yes, we're an assault ship, and that's our primary role, but it could be anything."

"The other side is we're the Fleet Flagship and, with RM350 and D-Day 70, it's trying to balance all our work – and then Cougar 14."

Along with sister ship Albion, Bulwark can carry 256 troops, with their vehicles and supplies, and this can be pushed up to 405 troops. For Joint Warrior there were around 500 personnel aboard.

Her vehicle deck can hold 31 large trucks and 36 smaller vehicles such as Land Rovers and Vikings, and she can carry armoured vehicles such as the Challenger 2 Main Battle Tank.

Bulwark recently finished a maintenance period in Devonport Naval Base and completed an intensive period of Operational Sea Training ahead of Joint Warrior.

Capt Bassett added: "We've got a really good story to tell – with RM350 we will be in London for seven days."

"We shouldn't forget our wider remit. We are a platform to send a message on behalf of UK plc."

Capt Bassett, who took command in January, paid tribute to the ship's personnel.

"The key thing is people. We ask a lot of them, in time and effort, but for them to achieve everything with their positive attitude."

"They do it all with a smile – Bulwark is not just an assault ship."

■ D-DAY commemorations, see page 28

THINGS go wrong on exercises – lessons learned is one of the reasons they are staged in the first place.

Weather closes in. Machinery breaks. People fall ill.

It is dealing with the unexpected that helps hone skills that will be priceless when they are called on for real.

Admittedly, such variables cause grief for planners – and for Reservists who have to help put right what has gone wrong.

Joint Warrior relies heavily on Reservist augmentees, but life at the sharp end doesn't necessarily mean fighting a ship at sea or storming ashore.

Some of the most challenging work is that undertaken by the logisticians, such as those at Forward Logistics Sites (FLS) on the coast between the Rhins of Galloway and the Outer Hebrides.

For these small teams, the Joint Warrior scenario blends seamlessly into reality – a broken piece of kit on a warship needs to be replaced, whether the scenario is fictitious or not.

There is also an ever-changing programme of flights to be arranged using military and civilian helicopters.

Take the FLS based at HMS Gannet, at Prestwick Airport.

Perhaps not a typical FLS – the logistical chain managers were co-located with a dedicated air movement controller.

And perhaps not a typical day – the fog was capricious and travel plans changed by the minute.

But it certainly hinted at the challenges faced by military logisticians, and spoke volumes about the patience of those trying to make sure everyone, whether ashore, afloat or aloft, was happy.

Gannet FLS ran extended office hours, though staff were on call round the clock.

Prestwick was familiar territory to air traffic controller Lt Cdr Steve Deeney, a former regular who is now a member of the RNR Air Branch.

He used to work across the runway at the Scottish ATC, and now 'stays current' at Culdrose, though he is starting a new career in small-scale landscape gardening and greenkeeping.

Steve was not part of the FLS – he was the HTUFT (Helicopter Taken Up From Trade) Liaison Officer – but in practice he worked closely with fellow reservists manning the site, ABs Gary Baird and Gavin Murphy.

One minute they were organising the refuelling of a French helicopter, the next working out how to get an urgent delivery out to one of the frigates.

VIPs needed to be slotted into the flying programme alongside visiting journalists, and the FLS 'office' – a large commandeered room – also served as a passenger lounge and mail depot.

The FLS team and Lt Cdr Deeney also worked with two volunteer Army aircraft marshalls – Ptes Alex Newnham and Ben Proctor – members of the RAF Odiham-based Joint Helicopter Support Squadron.

■ Seaborne lifesavers, see page 4

of 16th-Century Edingham Castle, near Dalbeattie, more than 40 miles to the east.

For 40 Commando, the exercise was their final major test before they assume the role as Britain's on-call commando unit.

The three regiment-sized commandos – 40, 42 and 45 – in 3 Commando Brigade take it in turns for 12-month periods to be ready to respond to global events, should the government require it.

Standing down from that role in a matter of weeks is 42 Cdo, based in Bickleigh, just outside Plymouth and, for the sake of Joint Warrior, playing the bad guys.

During Joint Warrior military personnel fired 1,250 rounds of 105mm ammunition, 140 rounds of 81mm, nearly 500 rounds from 4.5in guns and seven 1,000lb bombs were dropped.

For the Taunton commandos it's been bread-and-butter stuff.

"Launching from sea and assaulting the enemy is what the Royal Marines have been doing for 350 years," said Capt Luke Gobell, a troop commander in 40 Cdo's Alpha Company.

"Joint Warrior has been an excellent chance to practise this ability some more and roll out the whole Commando into a large exercise with lots of different ships, aviation and vehicles."

Col Kevin Oliver, Deputy Commander of 3 Cdo Bde, said working with NATO partners on large-scale exercises such as Joint Warrior was essential for future and current partnerships.

"We normally seek to do operations in a coalition – and one of our key partners is the Royal Netherlands Marine Corps.

"We have a long-standing relationship with them which last year was 40 years old."

One of the scenarios saw refugees safely evacuated by HMS Bulwark.

More than 60 naval personnel from the flagship and around 30 Royal Marines of 539 Assault Squadron set up a facility on Craignarget beach near Stranraer to process entitled citizens.

Overheard on the beach as a heavily-pregnant woman wails:

Refugee: "Help us! She is going into labour. She is going to have a baby!"

Royal Marine: "Congratulations."

Refugee: "It's not mine..."

The 'pregnancy' was one of the issues presented to Royal Navy personnel – others included refugees unable to prove they were entitled to be evacuated (making them angry) and people determined to try to outrun Marines in a bid to reach the landing craft.

Aircraft handler Naval Airman Ella McKenzie said: "My role today is as a researcher – the team that check the visitors over – and as I was patting down the lady playing a pregnant non-entitled civilian, she began to pretend to give birth, which was definitely a surprising part of the role play."

HMS Bulwark's Weapon Engineer Officer Cdr Gavin Edward took on the role of media officer for the scenario.

"The pregnant woman here is not entitled, but what we have done (and you would expect us to do so because we are a caring organisation – it is not as if the hearts have been ripped out of us) is provide her with shelter and we will look after her needs and give her appropriate

privacy until she can be seen by local medical facilities.

"But we will not be bringing her on the ship."

Tents providing medical help and food plus a media cell were set up, with Royal Marines creating a ring of security to ensure a well-managed situation, and the safety of both Naval personnel and those being evacuated to Bulwark and on to Liverpool (not really, just the scenario).

Cdr Edward added: "Bulwark's ship's company is processing the Entitled Personnel through a facility on the foreshore. They have been asked to process up to 150 such people, who are coming in in dribs and drabs along the beach."

"Because of the tide the area of beach we have to cover is getting larger and smaller as the day goes on."

Cdr Edward said one of the biggest challenges facing his team was ascertaining someone's entitlement to be evacuated.

Once it has been established they are entitled, they undergo a strict process.

First of all they are security screened.

"What we are trying to make sure is we do not want someone to get on board the ship who has got a gun or an IED, or even the enemy getting through to pose a threat to the ship's company."

"We also make sure bags are searched for any explosives or illegal substances."

The second stage is confirming the applicant's identity, followed by checking to see if they require medical attention – RN medics form part of the team.

The third stage involves a visit to the tea tent for a hot cuppa.

"Then they are ready to be transported out to Bulwark, which is the most fun

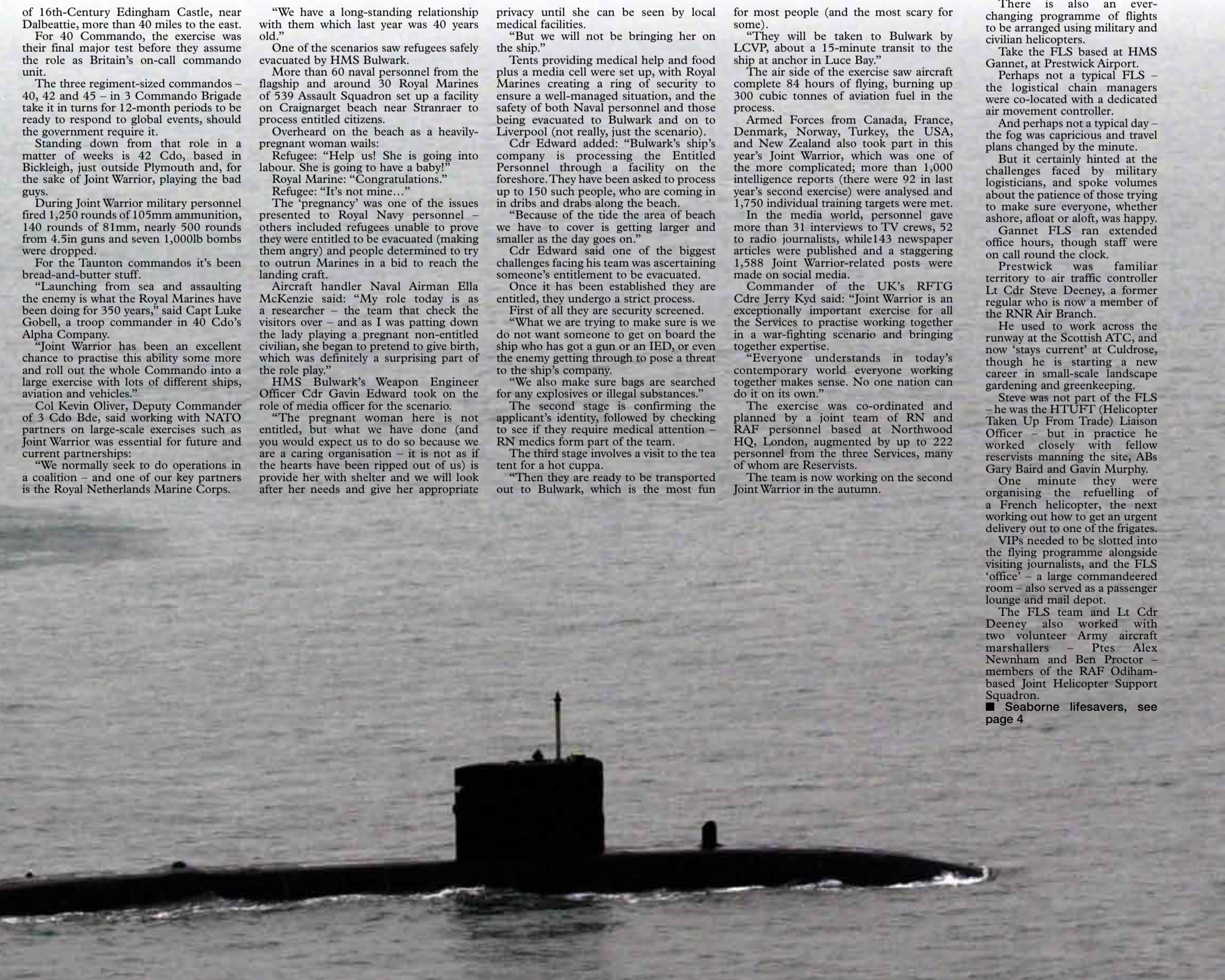



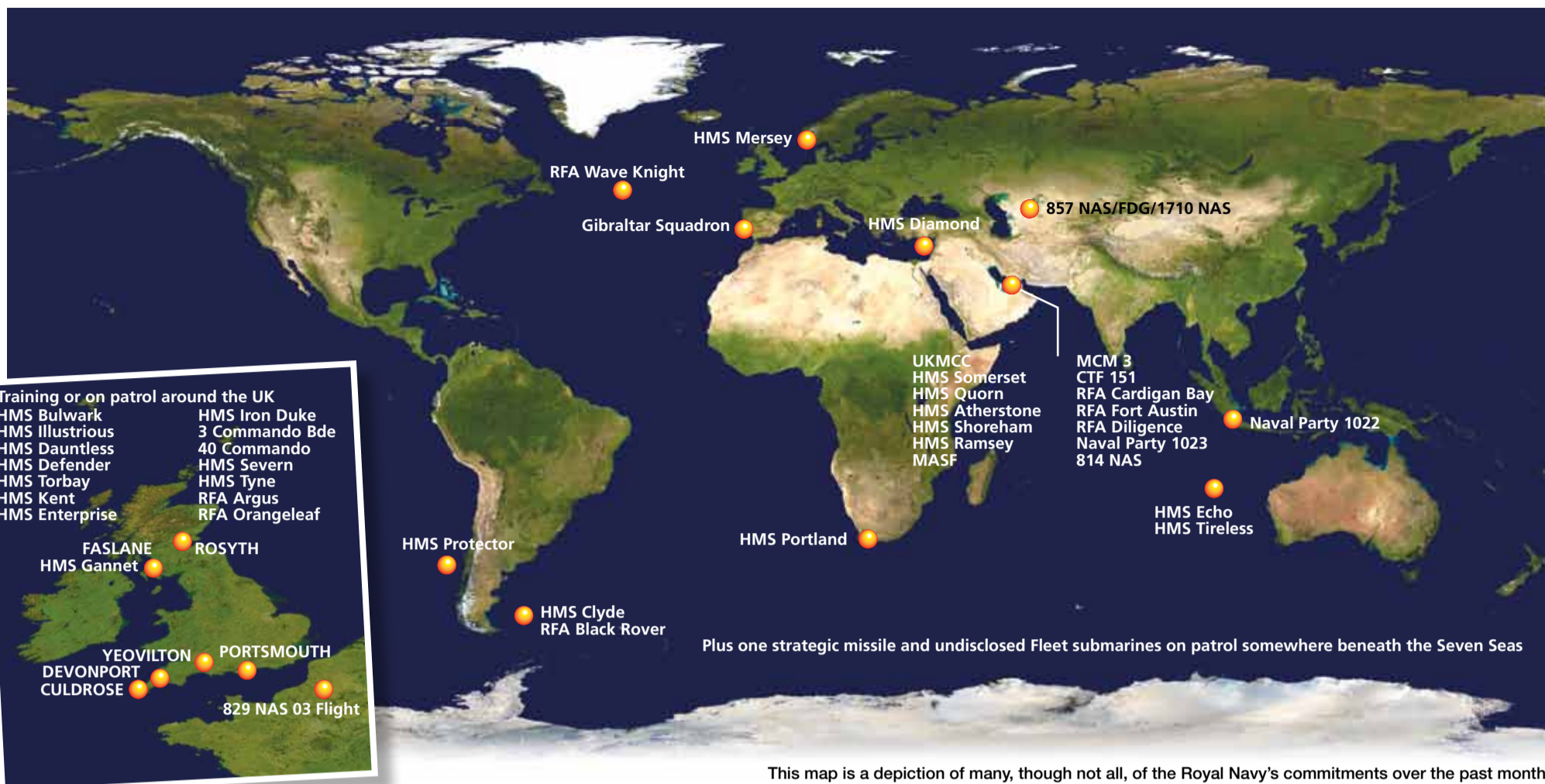

Plus one strategic missile and undisclosed Fleet submarines on patrol somewhere beneath the Seven Seas

This map is a depiction of many, though not all, of the Royal Navy's commitments over the past month

**ROYAL NAVY** **FLEET FOCUS**  
Protecting our nation's interests

# Seaborne lifesavers

NEW technology has been the theme for much of the Royal Navy's work during the past month, led by the aircraft **Lightning II**, which is set to grab the headlines for years to come.

The futuristic F35 strike fighter will make its international debut in July at the Royal International Air Tattoo at Fairford, Gloucestershire, followed by an appearance a few days later at the Farnborough Air Show (see page 6).

The aircraft – an Anglo-American venture – will begin flight trials in 2018 with **HMS Queen Elizabeth**, which is now in the 100-day countdown to being named by the Queen (see page 15).

The Royal Navy's new stars also include the Artisan radar system trialled by **HMS Iron Duke**, involving the firing of Seawolf missiles off the Dorset coast (see page 9).

And talking of firepower, the Navy's future anti-ship missile has received a £500m investment. Wildcat helicopters will carry the **FASGW**, the successor to the Sea Skua (see page 9).

As for Wildcat itself, a helicopter from **700W NAS** joined **HMS Dragon** for Exercise Joint Warrior – the first time it's embarked on a British warship for the duration of the war game (see page 8).

In Portsmouth, a specialist unit is developing the future of Royal Navy minehunting and surveying. The **MASTT** team is testing motor boat Hazard which has the potential to become a remote-controlled mother ship for a 'family' of mini-submersibles to seek and destroy mines or scan the seabed (see page 14).

Also in Portsmouth, the results of a £4.5m investment in the **National Museum of the Royal Navy** went on show. In Gosport £7m has been spent bringing **HMS Alliance** back to life (see pages 16 and 17) – an investment aimed at nearly doubling visitor numbers at the submarine museum, while more than 700,000 visitors are expected to pass through the gates of the historic dockyard this year.

Thousands of Royal Navy and Royal Marines personnel headed north to Scotland for the first Joint Warrior of the year. The largest naval war game in European waters in 2013 saw elements of Army and RAF working alongside RN ships, led by the Fleet Flagship **HMS Bulwark** (see pages 2 and 3).

Also taking part in the exercise was **RFA Argus**, which put its Primary Casualty Receiving Facility to the test in dramatic fashion (see right).

Prior to joining Joint Warrior, **HMS Dauntless** demonstrated her manoeuvrability by forming a 'doughnut' as she ran both engines at full speed, turning to port and starboard (see page 6).

Thousands of miles away in the Southern Indian Ocean, survey ship **HMS Echo** and T-boat **HMS Tireless** joined the international search for missing Malaysian Airways flight MH370 (see page 5).

The ship's company of **HMS Portland** paid their respects to King Neptune as the frigate crossed the Equator in the early stages of her seven-month patrol of the South Atlantic (see pages 20 and 29). On her way south the Devonport-based frigate trained with ships from ten nations, half of them African, for the fourth Saharan Express exercise.

**HMS Protector** ventured farther south than ever before – just 1,500 miles from the South Pole – as the ice patrol ship continued her scientific work in Antarctica with a visit to Marguerite Bay (see page 7).

And finally, in this 100th anniversary year of the beginning of the Great War, air and ground crew from **829 NAS** paid homage to the men of the **Royal Naval Division** by visiting the battlefields where the sailor-soldiers fought (see page 42).

ROYAL Marines stretcher bearers carry a battlefield casualty from the flight deck of RFA Argus as Royal Navy medics prepare to begin their fight to save her life.

Moving her down into the Primary Casualty Receiving Facility (PCRFF) on board the ship, the medical staff of 250 personnel are fully stood up across their departments to ensure the casualty is stable.

Set to the same standards as any NHS hospital, the PCRFF is tested twice a year and under Exercise Medical Endeavour the staff are put through their paces with a number of challenging scenarios to ensure their skills and the set-up is fully validated.

RFA Argus was off the coast of Scotland near Stranraer where, as well as holding Exercise Medical Endeavour, she was operating as part of Exercise Joint Warrior.

Volunteers play the role of casualties with specialist make-up depicting terrible injuries with a number of different issues which the team must work to resolve.

RFA Argus is also an Aviation Training Ship which works with the Royal Navy across the world, but also holds the specialist PCRFF facility on board that can be used in global operations.

Able to receive casualties from the sea, in the event of maritime attack, and also from land when supporting Royal Marine or Tri-Service operations, the facility ensures that casualties are treated and stable – for up to seven days – before eventually moving them to the Queen Elizabeth hospital in Birmingham for longer term rehabilitation.

Cdr Danny Follington CO of the PCRFF said that many lessons in critical, battlefield, care had been learnt from Afghanistan and, as a consequence, lives were being saved.

He said: "Deployed hospital care is invested in this vessel. Our Maritime in Transit Care Team can fly forward, ventilate, resuscitate, give blood



● Above left, A casualty is carried from the flight deck of RFA Argus by Royal Marines stretcher-bearers, accompanied by the Maritime In Transit Care Team  
● Above right: A casualty has a CT scan  
● Left: Surg Cdr Phil Coates looks at the images from the CT scan

Pictures: PO(Phot) Si Ethell

transfusions and bring patients back. It's one of the lessons we learned from Afghanistan.

"Another is that we now hold 600 units of blood on board and we have the ability to bleed people if necessary – that instant access to blood supply has been shown to be critical to saving lives in Bastion and so we ensure that lesson has been brought to the PCRFF as well.

"We are set up in the same way as any trauma hospital – there are four teams that can do resuscitation, we have ten Intensive Care Unit beds, 100 ward beds, a full surgical team,

microbiologists, radiologists, nursing teams and all of which work at either Derriford or Queen Alexandra hospitals in Plymouth and Portsmouth directly augmenting the NHS."

The PCRFF also boasts state-of-the-art equipment including a 64-slice CT scanner, installed during the last refit.

A casualty's journey on Argus sees them move from the Emergency Room to the CT Scanner, onto the operating theatre and then into intensive care, high dependency or recovery wards.

Consultant radiologist Surg

Cdr Phil Coates, who has twice deployed to Camp Bastion hospital, said: "The imaging side of things is key in major trauma, one of the things we learned from Afghanistan.

"We can do 3D reconstruction and if a patient has been hit with frag we can see where the organs which have been hit are and ensure they get exactly the right care.

"Imaging dictates what happens. It is a fantastic piece of kit, this is state-of-the-art stuff.

"CT scanning has been integral in saving the lives of British Servicemen."



# Working 24/7 to solve the riddle of MH370

**“IN MY 20 years’ experience with the Royal Navy this is the most challenging search I’ve ever seen.”**

Thus did HMS Echo’s Commanding Officer, Cdr Phillip Newell, describe the hunt which his survey ship – and submarine HMS Tireless – joined as the world’s navies tried to solve the greatest mystery in modern aviation.

For a fortnight last month the two Royal Navy vessels scoured thousands of miles of desolate Southern Indian Ocean – on and below the waves – hoping to find Malaysian Airlines Flight MH370 and provide closure for the families of the 239 souls aboard it.

Both Echo and Tireless had been in the Gulf region on their respective patrols – the survey ship was heading for the Seychelles to continue her data gathering, the submarine was acting as the RN’s duty boat east of Suez – when they were diverted.

It took the pair nearly a fortnight to reach the rough search zone, 1,000 miles from the western seaboard of Australia.

More than ten ships and a similar number of aircraft from Australia, Malaysia, China, New Zealand and the USA, plus the UK, were committed to finding the wreckage of the Boeing 777 which disappeared on a routine flight from Kuala Lumpur to Beijing on March 8.

Analysis of data sent back by the aircraft suggested it went down somewhere in the Southern Indian Ocean to the west of Perth – but that was as accurate a location as the experts could provide.

They ‘narrowed’ that search down to an area at least the size of the North Sea – or as Australia’s second most senior military

commander, Air Marshal Mark Binskin, put it: “We are looking for a needle in a haystack, but we haven’t found the haystack yet.”

When Tireless and Echo arrived on the scene the focus was finding the airliner’s black box – the Flight Data Recorder, with a transponder sending out a ‘ping’ to help those searching for it... except that its battery had little more than a week or so to run.

Initially Echo searched around 1,000 square miles of seabed a day using her HiPAP sonar – a probe protruding from the ship’s hull.

It was specially adapted to pick up any transmissions on the black box’s frequency – the first time it had been used this way by the ship.

Even with such refinements, however, it was limited to a range of just 4,000 metres – about two-and-a-half miles – in waters which were at least 1,700 metres deep, usually at least 3,000, and in places the seabed was a good 6,000 metres, or nearly four miles, down – deeper than the wrecks of the Titanic and the Bismarck.

Echo did pick up several possible contacts – but sadly none of them proved to be from MH370’s black box.

The ship also posted lookouts around the clock, scanning the ocean for possible debris.

HMS Echo’s duty swimmer AB Joshua Ruff was sent into the ocean on several occasions to recover objects – again none of them turned out to be from the doomed airliner.

The Devonport-based ship’s involvement in the search – codenamed Trenchmore by the UK, Southern Indian Ocean by the Australians who were overseeing the international effort – was not confined to her eyes and ears.

To help the Australian vessel Ocean Shield, which was acting as the focal point of the search operation, Echo lowered her CTD probe – Conductivity, Temperature and Depth – thousands of metres to collect data about the water.

“One of the best ways we could help Ocean Shield was by telling them what was going on in the environment,” said Lt Cdr Nick Townley, Echo’s operations officer.

“We told them what the temperature was, what the salinity was, what the speed of sound was and a whole bunch of other information.”

Whilst many of the photographs and television footage of the search suggested calm seas and idyllic sunsets, the hunt for the black box was repeatedly hampered by bad weather – described by Tireless’ CO as “some of the most inhospitable sea conditions ever experienced by my crew”.

Nevertheless, during her 16-day involvement in the search, the veteran T-boat – the only submarine involved in the mission – scoured some 9,000 square miles of seabed... an area larger than Wales.

The submarine spent an average of 21 hours a day with her sonar operators listening for the ping – breaking off only to send and receive reports.

It demanded, says Cdr Griffiths, “the steadfast commitment of my team, some in their very first months at sea”.

That same steadfast commitment was shown by the 60 men and women aboard HMS Echo, says Cdr Newell.

“My ship’s company worked 24/7 to find MH370. They are

young, bright and enthusiastic and stepped up to every challenge in the search for the missing aircraft. I am immensely proud of them.”

Lt Andy Thomas said his engineering team worked around the clock to ensure Echo reached the search area in good time – and that the equipment aboard the Devonport-based ship was ready for a mission beyond the norm.

“My engineers worked incredibly hard to ensure the main engines and electrical propulsion drives have been running at full power, in order to reach the search area in the shortest possible time,” said the 31-year-old from Fareham.

“At the same time, we checked and maintained the survey equipment held on board to allow us the best possible chance to find the aircraft flight data recorder.”

“Despite the sombre nature of our task I feel privileged to be granted the opportunity to assist in hopefully bringing some closure to the families and loved ones of those involved.”

His sentiments were echoed by PO Simon Hamilton, in charge of seamanship aboard the survey ship.

The 42-year-old from Coventry said: “We train hard to do what we do and sometimes it is hard to deal with what is placed in front of us.”

“At the end of the day, if we can find answers for the relatives of MH370 then it will be a good day for the Royal Navy and a good day for me.”

As *Navy News* went to press, no-one involved in that enormous search was yet able to supply those definite answers.



● A Royal Australian Air Force P3 Orion – one of numerous long-range patrol aircraft involved in the search for the missing airliner – conducts a flypast of HMS Echo and (below) the survey ship’s bridge team scans the surface of the Southern Indian Ocean for any debris from the passenger jet

Pictures: LS Andrew Coutanche

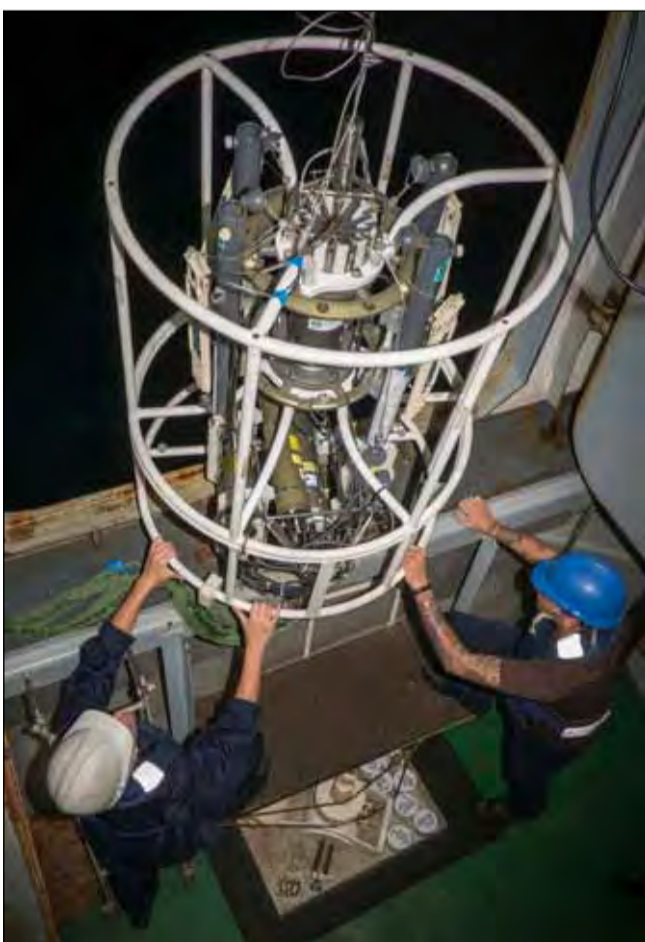

● Echo’s sailors prepare to launch a CTD probe into the Southern Indian Ocean at night



**The Royal Naval Benevolent Trust**  
Supporting The RNBT Family



Men and women of the Royal Navy and Royal Marines serve their country, often at times of danger. Established in 1922, the RNBT helps non-commissioned Sailors, Marines and their families (The RNBT Family) throughout their lives.

Your donation will help us to help them.

The Royal Naval Benevolent Trust, Castaway House,  
311 Twyford Avenue, PORTSMOUTH, Hampshire, PO2 8RN  
T: 02392 690112 F: 02392 660852 E: rnbt@rnbt.org.uk www.rnbt.org.uk





## F35 flies in UK skies

THE British people will see the aircraft which will give wings to the Navy's future carriers for the first time this summer.

The F35 Lightning II will make its international debut at two of the world's biggest air shows just a few days after HMS Queen Elizabeth is named by the monarch in Rosyth.

Never before has the futuristic strike fighter – the first 'fifth-generation' jet to be flown by British pilots – been on display outside the USA.

But it will be flying at the Royal International Air Tattoo at Fairford in Gloucestershire – the largest military air show in the world – from July 11-13.

The next day the Lightning II will fly into Farnborough Air Show for a six-day appearance – the first four days to the aviation and military industry, then on July 19 and 20 to civilians.

"July will be a real milestone in the rebirth of the UK's carrier strike capability," said First Sea Lord Admiral Sir George Zambellas.

"Alongside the naming of HMS Queen Elizabeth by Her Majesty the Queen on July 4, we can now also look forward to seeing the F35B – the Lightning II – flying on the international stage for the first time."

FAA and RAF pilots have been flying the F35 in the USA since last year, while ground crews and engineers have spent several years determining how to maintain an aircraft which is two generations more advanced than the legendary Harrier.

The decision to fly the F35 outside the USA for the first time follows discussions between Defence Secretary Philip Hammond and his US counterpart Chuck Hagel.

Although the F35 is assembled at Fort Worth in Texas by Lockheed Martin, the fighter is an Anglo-American venture with around one seventh of it designed and built in the UK.

Given that history and that investment by our nation, Mr Hammond said it was "entirely fitting that the F35's first stop outside the United States will be in the UK."

Britain has bought three trial models of the jump jet version of the Lightning II, with orders for more aircraft due to be placed over the next few years.

The UK's first operational Lightning II formation, 617 Sqn – an RAF squadron but with personnel drawn from the Air Force and Fleet Air Arm – will begin training in the USA later this decade before moving to RAF Marham in Norfolk in 2018 ready to begin flight trials with HMS Queen Elizabeth.

In due course, the Fleet Air Arm will form its own F35 squadron, 809 NAS, again a joint RAF-RN venture.



**CARVING** what is known as a 'maritime doughnut', HMS Dauntless demonstrates her impressive manoeuvrability as she prepares to join the largest war games held in north-west Europe this year.

Fresh from a four-day visit to her twin city of Newcastle, the destroyer struck out in the North Sea to join nearly three dozen warships, two dozen different types of aircraft, and upwards of 13,000 military personnel converging on Scotland's east and west coasts for Exercise Joint Warrior.

The three-week-long war game (see pages 2-3) saw Dauntless put to the test in her primary role: shielding a task group from air attack courtesy of her Sea Viper missiles.

She also came under attack from fast surface craft such as jet skis and RIBs, some of the hardest foes to shake off,

despite Dauntless bristling with weaponry – not least her recently-fitted Phalanx automated Gatling guns which spew out over 3,000 20mm rounds a minute at targets in the air or on the water.

So to prepare for that coming test, the Portsmouth-based warship was thrown around in the North Sea at speed.

The 'doughnut' was created by testing both engines at full speed – over 30kts – and turning left or right (in this photograph, hard to port).

Throughout Joint Warrior, the destroyer had a Merlin helicopter from 829 Naval Air Squadron in Culdrose as aerial support; it was from its cargo door that her aircrewman PO 'Taff' Morris took these photographs.

During the ship's stay on the Tyne, Dauntless took on youngsters from their affiliated

school in the sporting arena – and were roundly beaten.

Five members of the destroyer's ship's company dropped in on the Percy Hedley Foundation in Newcastle to meet some of the staff and students whom the Type 45's fundraising helps to support.



The foundation – which has long-standing ties with the Royal Navy; Dauntless' predecessor HMS Newcastle was a supporter for many years – looks after children with cerebral palsy, sensory, speech, language and communication difficulties from all over north-east England and Scotland.

After meeting some of the staff, the Dauntless team were invited to play a game of bocce – an adapted version of bowls – and were on the end of a bit of drubbing.

Pupils also showed the visitors some of their artwork featuring the Portsmouth-based warship and promised to keep an eye out for her (occasional) appearances on the telly.

"This is a very worthy and important cause. By far, the best part of our contribution is seeing that the kids get a lot of it," said Lt Will Jones, Dauntless' deputy weapon engineer officer.

"For us, it was a fantastic opportunity to see first-hand the extremely important work the foundation does."

Head teacher Lynn Watson added: "Pupils have followed Dauntless' progress since the days of her fitting out."

"We very much hope our contact with the ship continues – she has a special place in the hearts of staff, the children and their families, some of whom have visited the ship. We really appreciate the continued support."

## Tyne ensures calmer Chameleon

HMS Tyne put her everyday fishery protection duties to one side and played the part of a mini assault ship as she joined the Army, RAF and Royal Marines for an eye-catching exercise off Dorset.

Within sight of the chalk cliffs of the Jurassic Coast, an RAF C130 Hercules dropped troops into Studland Bay – the curtain-raiser to Exercise Chameleon.

The aim was to test all three Forces to see whether troops could parachute into the ocean, be safely picked up, taken to a ship, then plan an assault ashore, before carrying it out.

And they could.

Tyne and her two River-class sisters have – for the size of ship – a fair bit of space aboard, which was made use of once her medium inflatable boats (MIBs) had recovered the troops and their kit from the bay.

Once aboard, and settled in to their new floating home, the troops – Army and Royal Marines commandos – quickly got to work on the training element.

A key function for Tyne, and the embarked forces, was practising the ability to insert, support and recover troops from ship to shore.

To do this, rapid launch and recovery boat drills were carried

out in various weather conditions, alongside armed boarding and search drills, ending with a strategic disembarkation from ship into 'hostile' territory.

"Chameleon demonstrated the wider utility of the River class," said Lt Cdr Bob Laverty, Tyne's CO.

"It was of great benefit to my ship's company to operate with other elements of the Armed Forces and has demonstrated the key role of the Royal Navy across the full spectrum of military operations."

With the exercise over, Tyne resumed her more usual mission.

## Portsmouth strengthens bond with its warships

EVERY one of the 41 ships in the Royal Navy's Portsmouth Flotilla will forge an even stronger bond with their home city after a unique affiliation was signed with the city.

The leader of Portsmouth's council and the Second Sea Lord Vice Admiral David Steel put their names to a special scroll marking the new link between the city and its sailors.

The affiliation, signed aboard the RN's newest warship HMS Duncan, binds the civic authority with the Portsmouth Flotilla – 'parent' to the second largest ship in the Fleet (veteran helicopter carrier HMS Illustrious) down to some of the smallest (P2000 patrol boats), embracing half a dozen Type 23 frigates, all six Type 45 destroyers and every Hunt-class minehunter *inter alia*.

Until she left service in 2008, ice patrol ship HMS Endurance was affiliated with Portsmouth (her successor, HMS Protector, is twinned with Cambridge – and is about to switch home base to Devonport).

So instead of an individual ship, the council and flotilla have agreed to an all-embracing affiliation.

"Portsmouth is different from affiliations for other ships – they may visit their affiliated city once a year," explained council leader Cllr Gerald Vernon-Jackson.

"Here in Portsmouth this is their home port and they are with us all the time. This is why we thought it was right to be affiliated to the whole of the Portsmouth flotilla."

Cdre Paddy McAlpine, Commander of the Portsmouth Flotilla, added: "The crews of these ships and their families see Portsmouth as their home. Portsmouth is home for the majority of the surface ships of the Royal Navy. We are really pleased that the city and the Royal Navy want to show this relationship through this new home port affiliation."

"New ships joining the flotilla will also receive this affiliation, so the new aircraft carriers will receive this affiliation when they arrive here."

## Dive teams recognised

ELITE naval divers who quietly – but crucially – support the Royal Navy's front-line operations in home and foreign waters have been singled out for their deeds.

The 65-strong Fleet Diving Group, based at Horsea Island at the northern tip of Portsmouth Harbour, is parent to three front-line formations: Fleet Diving Unit 1, which is at immediate readiness to react to threats of terrorism at sea and on land 365 days a year; and Fleet Diving Units 2 and 3 which provide security for all RN ships around the globe – their speciality is port and harbour clearance, searching berths, jetties and ships.

FDU2 were especially busy in the autumn of 2013 in support of the Cougar amphibious deployment led by HMS Bulwark and Illustrious to the Mediterranean and Middle East, but they also supported the first frigate to visit Libya since the fall of the Gaddafi regime (HMS Kent) last spring.

FDU3 have only re-formed in the past 12 months and have spent a lot of the time east of Suez, working with the counterparts from the USA, Netherlands, France, Bahrain and Singapore – invariably working for long periods in austere conditions.

All this work – and more – was carried out at "an unrelenting operational tempo" by a team of divers who "remained extremely motivated with a willingness to deploy in a positive and professional manner". That has earned the group the Diving Unit Effectiveness Trophy.

The Fleet Diving Group is part of the (not much larger) Fleet Diving Squadron – the parent unit for 150 divers in Southern Diving Units 1 and 2 (in Plymouth and Portsmouth respectively), Northern Diving Group at Faslane as well as the FDG.

## Torbay's day has come

LONG out of these pages as a result of a lengthy refit, HMS Torbay is beginning to make more regular appearances now that revamp is done (but not too frequent, such as the nature of submarine operations).

The Devonport-based T-boat has emerged from her Revalidated Assisted Maintenance Period (RAMP), which has seen the boat and her sensors and weaponry given a new lease of life – and the same goes for her nuclear reactor.

It's taken more than two years to overhaul the 27-year-old hunter killer, work carried out not just by teams of experts from defence firm Babcock but also some of the crew, who've stayed with her throughout – and have dispelled the common misconception that it is 'easy being on a RAMP boat with early finishes and long weekenders'.

They've come through an extremely busy period full of many challenges in one of the most technologically-sophisticated projects faced in engineering.

Their work done, Torbay is being turned into a lean, mean black messenger of death again so she can resume patrols – beginning with Joint Warrior (see pages 2-3).

"We are genuinely excited about the prospect of heading out to sea and getting the boat underwater for the first time in over two years," said her CO Cdr Andy Johns.

"With a busy and interesting programme to look forward to this year, we can't wait to get on with it. 2014 will be the year of Torbay."

SEAFARER BOOK OF THE YEAR

VOTE FOR YOUR BOOK OF THE YEAR!

Tell us your favourite books and authors of 2013 for a chance to win one of 5 Kobo e-readers!

Terms and conditions apply. visit: [marine-society.org/seafarerbook](http://marine-society.org/seafarerbook)

MARINE SOCIETY  
A charity registered in England and Wales 313013 and in Scotland SC037808

Vote here: [marine-society.org/seafarerbook](http://marine-society.org/seafarerbook)



# Closing in on Pole position



## Brocklesby's mini tour of duty over

HMS Brocklesby's short stint with a NATO minehunting force in the Med ended on a fine spring day when she returned to her native Portsmouth.

And despite the brevity of the deployment – two-and-a-half months – there was a different person in charge at the end (Lt Cdr John Cromie, who took over from Lt Cdr Ben Vickery in Gib).

Foul winter weather delayed the Hunt-class ship's arrival in the Middle Sea – she spent numerous days in Brest sheltering from winter storms.

When she belatedly slotted into the international force – Standing NATO Mine Counter Measures Group 2 – she took part in exercises from the central to the eastern Mediterranean, reaching their climax around the island of Crete.

Also committed to the group were the minehunters *Weilheim* (Germany), *Chioggia* (Italy) and *Evropi* (Greece).

The silhouette of the latter was instantly recognisable – she's a sister of Brocklesby who served as HMS *Bicester* until she was sold to the Greeks in 2001.

"It was great to see so many countries operating together," said mine warfare specialist PO James 'Soapy' Watson.

"We have such different equipment but everyone works at the same fast pace to get the job done. It was particularly good to see another Hunt-class working with us, albeit now with Greek sailors."

After 6,500 miles sailed the crew headed off on leave. They'll return to work to begin high-tempo training ahead of deploying to the Gulf next year.

**YOU'VE** seen one snow-capped forbidding rocky foreshore in Antarctica, you've seen them all.

Or maybe you haven't. Not in HMS Protector's case certainly, as the ice patrol ship ventured farther south than ever before – just 1,500 miles from the South Pole – as she continued her scientific work around the frozen continent.

On the latest stage of her work to improve seafaring charts of remote waters, supporting the work of British Antarctic Survey scientists, and conducting scientific studies, the distinctive icebreaker reached Marguerite Bay, roughly half-way down the western shores of the Antarctic Peninsula.

The furthest point south recorded on her charts was 68° 12'S – 8,900 miles from home waters, 1,500 miles from the

southernmost point on the planet, and 850 miles from Cape Horn, the most southerly tip of South America.

As part of a demanding work period in Antarctica as the Austral summer draws to a close, Protector has been working alongside the British Antarctic Survey scientists to help them in their studies of the far South.

She first arrived at Rothera Research Station, the BAS' most important base in the region, to deliver aviation fuel for its aircraft to use over the Austral summer and stockpile for the winter.

In a single night, Protector's engineers pumped 150,000 litres from their tanks – that would fill up a good 2,700 family cars (not that you can drive them in this part of the world...).

While the fuel pumps were running, the ice ship's junior rates invited their shipmates and BAS personnel to a barbecue in the snow, enjoying hot dogs and burgers as the sun (and temperature) went down.

And then it was on to Marguerite Bay.

"This voyage marked an important milestone for both the deployment and the history of the ship," said HMS Protector's First Lieutenant, Lt Cdr Jason Varty. "At 68° 12'S Protector has never been as close to the South Pole."

After Marguerite Bay, the ship headed north – the only way to go now with autumn beginning – and Detaille Island to complete another part of her tasking: hydrographic surveying, to update

Admiralty charts used by many of the world's mariners.

With a small part of a previous survey to complete, the brightly-painted icebreaker arrived in the area only to find herself in extremely challenging conditions.

"Bergs of every size – small 'growlers' to 'large bergs' the size of Devonport Naval Base – were all around the area," said Lt Cdr Varty.

Tonnes of densely-packed ice – with icebergs of all shapes and sizes surrounded the ship – made surveying extremely difficult as the sailors rely on exact measurements of tide and depth.

PO(SR) Kerry Collins, who is on her ninth season in Antarctica, bravely led Protector's survey motorboat team out to collect the required data, returning successfully with the measurements.

Picture: LA(Phot) Vicki Benwell, HMS Protector



# Whatever you think of your Armed Forces pension, we'll help you get the most from it.



The latest Armed Forces Continuous Attitude Survey shows satisfaction with pensions has fallen sharply over the past 5 years, across all three Services. But you can protect your interests and find out how to get the most from your pension by joining the Forces Pension Society.

### HOW WE CAN HELP

Armed Forces Pensions are complex and we can help ensure you get the most from your pension by advising when to leave (and when not to), commutation, how to deal with pension troughs, the impact of AFPS2015, the implications of redundancy, divorce, how you might be able to top up your pension, and much more. Help is available from our acknowledged Pension Advisory Service experts.

### INDEPENDENT, NOT-FOR-PROFIT

We value our independence as it enables us to serve the interests of our Members as their pension watchdog. We campaign to put right injustices in the system such as the case we are arguing now for all Service widows who remarry to be allowed to retain their pension. Our role includes holding the government to account to ensure the Armed Forces Covenant recognises the vital importance of pensions.

There is no other not-for-profit organisation dedicated to looking after the pension interests of the whole military community.



### PLUS VALUABLE MEMBERSHIP SERVICES

We also offer our Members a range of valuable through-life services with significant discounts from trusted affiliates.

### JOIN ONLINE NOW AND RECEIVE A FREE £100 CITY BREAK VOUCHER

Simply visit our website at [www.forcespensionsociety.org](http://www.forcespensionsociety.org) quoting Promo Code **NVN2014** (t's & c's apply). Membership for you and your partner costs just £35 per annum.

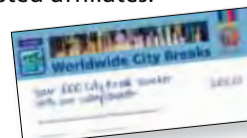

**Forces Pension Society** 68 South Lambeth Road, Vauxhall, London, SW8 1RL  
Tel: 020 7820 9988 email: [memsec@forpen.co.uk](mailto:memsec@forpen.co.uk) [www.forcespensionsociety.org](http://www.forcespensionsociety.org)

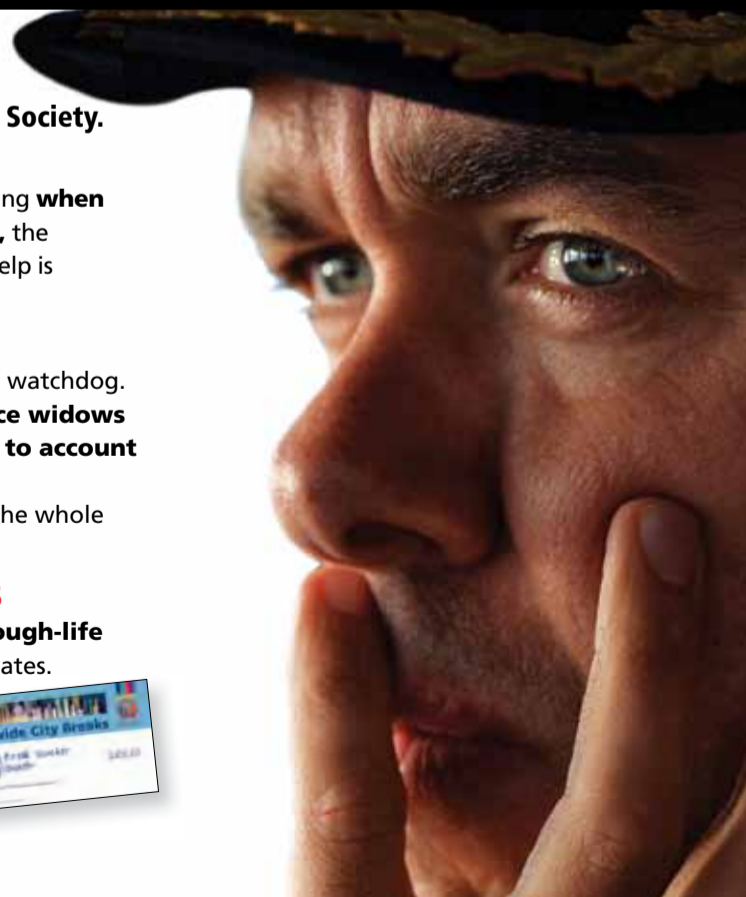

## JOIN US AND GET THE MOST FROM YOUR PENSION



# 'Scotland is as vital today to the Royal Navy as ever it was'

AHEAD of a keynote speech by Defence Secretary Philip Hammond on the effects of an independent Scotland on the Armed Forces of the United Kingdom – and the jobs and civilians who support them – First Sea Lord Admiral Sir George Zambellas spelled out the potential impact of the break-up of the union on the world's longest-standing and most famous naval force.

“On September 18, voters in Scotland will go to the polls to decide Scotland's future.

Campaigners and commentators have made much of the implications. As the professional Head of the Royal Navy, responsible for its fighting efficiency – and for this country's maritime security – I too have to consider the potential impact of independence on the Royal Navy's people, ships and submarines that help to keep this country safe.

I believe that independence would fundamentally change maritime security for all of us in the United Kingdom and damage the very heart of the capabilities that are made up of the Royal Navy, the Royal Marines, the RFA and Fleet Air Arm.

While the continuing United Kingdom would eventually adapt and cope, the deeper impact would be felt in Scotland which would no longer have access of right to the security contribution of one of the finest and most efficient navies in the world.

At the Battle of Trafalgar in 1805, almost one third of Admiral Nelson's men were Scots, and five of his 27 ships were commanded by Scottish officers. Just under 100 years ago, the Grand Fleet based at Scapa Flow sailed for the Battle of Jutland, the largest naval battle in WW1. And, during the Cold War, our ships and submarines deployed from Scottish bases to protect the UK's northern flank from the Soviet threat. In an unpredictable world, this history reminds us of the strength that the Royal Navy, and indeed the whole of the Armed Forces, draws from our bond with Scotland.

Today, the Royal Navy has 16 ships and submarines and two Royal Marines Commando units based in Scotland, with 3,250 of our sailors and marines serving there – very ably supported by over 2,000 civilians. Scotland is as vital today to the Royal Navy as ever it was.

As an island nation, the UK relies on the Royal Navy for credible strength at sea, to project our interests, support our trade, and work with UK and international shipping to help ensure the supply of raw materials to make industrial Britain 'Great'. Today 95 per cent of the UK's trade moves by sea and 80 per cent of our Liquid Natural Gas arrives by tanker from the Middle East. Wherever in the world our assets are deployed, they are providing security for the whole of the UK – and protecting all our interests.

For 44 years, the nation's strategic deterrent, based in Scotland, has been providing the ultimate constant guarantee of our security. Our submarine force is deployed worldwide, with HMS Astute in the Mediterranean, and HMS Tireless in the Indian Ocean searching for missing Malaysian airliner, along with our survey ship HMS Echo.

The Royal Navy is experiencing a renaissance, with significant investment in capable new equipment. The first of our two new aircraft carriers, HMS Queen Elizabeth, will be launched in Scotland by Her Majesty the Queen on July 4, having supported thousands of Scottish jobs during her construction. Populated with new fighters, helicopters and unmanned aircraft, she will grow in capability over the years ahead to deliver a historical return on this strategic investment. Combined with our existing frigates, destroyers, submarines and aircraft, these carriers will project the Navy's credibility into the future and provide fantastic career opportunities for our people, not only to become highly trained professionals but also to serve in a world-class Navy across the globe. A much smaller Scottish Naval force with limited ambitions would not provide the same appeal.

However, the intrinsic efficiency of our maritime forces, delivering such a full range of security capabilities, also presents a vulnerability. Optimised as they are, they cannot be subdivided meaningfully. An independent Scotland's claim on the Royal Navy would greatly weaken the carefully evolved 'whole', as bases, infrastructure, procurement, spares, personnel and training face a carve up. Officers, sailors, civilians and their endlessly supportive families, who come together from the four corners of our country to serve under the White Ensign, consider that they are serving as regulars and reserves in Her Majesty's Royal Navy of the United Kingdom. That is something special and precious we do not want to lose.

The effectiveness of the Royal Navy, following separation, would weaken the security of both nations, and while the UK would adapt and restructure to meet a changed set of responsibilities, we should be clear that the sum of two parts would no longer add up to the whole.

So, the UK's Navy – your Royal Navy – carefully optimised as it is for today's strategic needs, belongs to the 'whole' of the UK. It is stronger together – by design, by efficiency, and as history has proved for hundreds of years – by its fighting spirit.”



# Wild Dragons

ONE of HMS Dragon's flight deck team checks the strapping as pilot Lt Dave Neyland clammers out of the cockpit of his Wildcat amid the sternest test yet for the Fleet Air Arm's newest helicopter.

Wildcat – which will provide the aerial eyes and punch of the Royal Navy's frigates and destroyers for the next quarter of a century – joined the Type 45 for two weeks of Joint Warrior, the first time it's embarked on a British warship for Europe's biggest naval war game.

It's also the first time the helicopter – normally based at RNAS Yeovilton in Somerset with 700W Naval Air Squadron – has spent such a concerted time at sea.

From next year, Wildcat will start to replace the Lynx as the mainstay of aerial operations by Type 23 frigates and Type 45 destroyers, superseding a helicopter which in various variants has served the Fleet Air Arm with distinction for 40 years.

Although it looks similar to its predecessor, Wildcat is a different aircraft, from the way it handles, to the equipment aboard – which is a generation ahead of that on the Lynx.

Wildcat has undergone more than four years of trials which have tested the airframe to the limit and set the rules for what the helicopter can do on and off the flight deck. The emphasis has now shifted to how to use Wildcat on the front line – what the military call tactical development.

After a brief visit to HMS Dragon in the Irish Sea last month, pilot Lt Neyland and his observer Lt Sammy Haynes returned to the Portsmouth-based warship with their Wildcat and a full complement of engineers and technicians to maintain the helicopter for three weeks.

“This time the focus was



● The masts of a diesel boat tracking Dragon appear on the surface of the Irish Sea – as seen from the destroyer's Wildcat

working on tactical development – the chance to be at sea with so many other ships and submarines, from across the world, is not one to be missed,” said Lt Neyland.

The nature of Joint Warrior, which features pretty much every face of naval warfare: submarine, surface, fast-attack craft, amphibious assault – means it's about as thorough a workout

a new helicopter bristling with cutting-edge equipment can hope to find in one place.

So with more than 30 warships and submarines from over half a dozen Allied nations to play with, Wildcat clocked up 26 flying hours in 18 days – in a variety of different environments and weather.

“The range and clarity of the

sensors, including the radar and onboard cameras, meant that building the maritime picture was more accurate and faster than in the older Lynx,” said Lt Haynes, who was monitoring the reams of data the helicopter's suite of sensors was picking up.

Later this year Wildcat will go through two months of intensive Operational Sea Training with a Type 23 frigate to prepare ship and helicopter for deployment.

Wildcat is due to be declared operational in early 2015 and is due to deploy for the first time with a Royal Navy warship on the North Atlantic patrol next May – by which time Dragon's second deployment should just about be complete.

After a successful maiden deployment – eight months in the Gulf and eastern Mediterranean – the destroyer is devoting the first half of 2014 to preparing for her second tour of duty.

Following a high-profile visit to her twin city of Cardiff to receive the Freedom of the Welsh capital and Operational Sea Training, the Type 45 destroyer will deploy again in October – fewer than 12 months after returning from her last operational tour.

“This year has already been another of many firsts for Dragon and we were delighted to assist in this way to bring on the capability of this aircraft,” said Capt Iain Lower, the destroyer's Commanding Officer.

“It was fantastic for all of my sailors to work with the Wildcat team and to have the aircraft aboard a Type 45 for such a long period. A brand new aircraft on the Navy's newest warship is more evidence of the exciting future ahead of us.”

# A magnificent Endeavour

A STATE-of-the-art recovery centre in Plymouth to help sailors and Royal Marines recover from serious wounds and illness “knocks others into a cocked hat” according to the Duke of York – who officially opened it.

The £23m Naval Service Recovery Centre, funded by the charity Help for Heroes and run jointly with the MOD, is the first of its kind in the West Country.

The centre – two buildings, one providing specialist accommodation which was completed in May 2013, the second a rehabilitation centre finished at the end of last year – will provide treatment and support for wounded, injured and sick sailors and Royal Marines, veterans and their families.

Work began on the project in Devonport Naval Base in August 2011.

Parker VC building – named after Royal Marine Walter Parker who won Britain's highest military decoration in Gallipoli – has 60 single cabins, six family cabins, areas to meet and relax, a conference facility and 24-hour reception support.

The Endeavour complex features a gymnasium, eight medical consultation rooms, a ‘support hub’ for veterans, a hydrotherapy area, changing rooms and a 25-metre, six-lane swimming pool.

The facilities – coupled with the experience and commitment of the staff and the spirit of the patients – left a strong impression on the Duke of York.

“As an ex-serviceman I go round the country and see different things within all the Services,” he said.

“This centre is the most impressive I have seen and knocks the others into a cocked hat. It's humbling to meet those who have been injured and see how they cope and how they face their life in the future.”

The naval recovery centre is one of four centres H4H has helped to build and support since 2010 – but, as the charity's co-founder Bryn Parry pointed out at the opening: “Buildings are buildings and although this is a wonderful building, what matters is the people. We want people to be independent and live successful lives that they may not have had otherwise.”

Royal Marine Sgt Lee Riley, who was injured serving with the Corps in Afghanistan in 2011, has been making use of the Recovery Centre complexes.

“The Endeavour Centre is a fantastic facility and I will continue to use it even as a veteran as I will be leaving the service this summer,” he said.

“Help For Heroes have made a massive contribution in support of the Royal Navy and its new Recovery Centre and its users are very grateful.”

Maj Scotty Mills, Officer Commanding Hasler Company which is assisting 91 men and women in the Senior Service who have been seriously injured or are suffering from long-term illnesses, said the recovery complex was very welcome.

“It is now up to us to ensure that these facilities are used to their full potential and that our wounded sick and injured, both serving and veterans, get to benefit from both the services and capabilities that it offers,” he added.

## REDUNDANCY THROUGH INJURY?

SPECIALIST LEGAL ADVICE AVAILABLE

- Suffered a military injury?
- Need assistance for police interview/court martial?
- Employment issues?
- Need advice on AFCS claim?
- Have you been the victim of a medical mistake?



Contact Alex Rynn or Tean Butcher on

**Tel: 01522 512345**

Between 9am and 5:15pm. After 5:15pm, for Military Discipline Matters only, contact Alex Rynn on 07775 022268.



www.wilkinchapman.co.uk

wilkin chapman llp  
inc. gilbert blades  
solicitors



# Iron skies

WITH a loud roar and a flash of fire, a Seawolf missile erupts from its launcher – shattering the thin membrane cover – as HMS Iron Duke proves the Navy's new cutting-edge 3D radar system.

It's the first time the new radar – Artisan – has been used to track a sea-skimming target ahead of the missile knocking it out of the sky off Portland.

Iron Duke is the first ship in the Fleet to receive Artisan – also known as 997 in the Royal Navy – which she's been testing extensively around the UK since she completed a refit last year.

That revamp also saw her receive the latest version of Seawolf – a missile which has protected Royal Navy frigates from air attack for more than 30 years and been constantly updated over time to meet the latest threats in the skies.

After going through eight weeks of tough training in and around Plymouth, the frigate was on her way back to her home base of Portsmouth when the moment came to test the new Artisan and Seawolf for the first time.

Off the Dorset coast, Iron Duke waited for the trials aircraft to trail out its target on a very long tow wire.

Artisan successfully tracked the target – which acts like a sea-skimming missile – then passed the data to the Seawolf system to follow and shoot, successfully blasting the object out of the Channel sky with a direct hit.

"We had just finished eight hard weeks of training where we'd used Seawolf in simulation mode to defend ourselves against hostile aircraft and missiles," said Lt Cdr Chris L'Amie, one of Iron Duke's principal war officers who was directing the firing from the frigate's operations room.

"To cap off the training with a live shoot was hugely satisfying. I'm pleased the team performed well and we achieved the firing quickly and efficiently. It really boosted confidence in the new radar ahead of Iron Duke's deployment."

Lt Cdr Jim Hyde, whose Short Range Air Defence (SHORAD) team is responsible for both Artisan and the upgraded Seawolf, was aboard Iron

Duke for the successful shoot.

"Following a challenging trials and development programme, today was significant as it was the first time we have conducted a live firing with 997," he said.

"It was rewarding to see both the new radar and the upgraded weapon system operate together perfectly, successfully demonstrating end-to-end combat system performance, and validating a lot of hard work done by agencies across MOD and in industry."

Artisan is being fitted to the Royal Navy's Type 23 frigates as well as its two new aircraft carrier and assault ships Ocean and Albion. It could also be the principal air radar of the Type 26 combat ship, successor to the 23s, which enter service next decade.

As well as being able to track up to 800 targets simultaneously, it can do so if they're 200 metres from Iron Duke – that's roughly the width of the entrance to Portsmouth Harbour – or 200 kilometres (125 miles) away.

The Seawolf shoot was the icing on the cake for the 180 men and women aboard the ship who've spent the spring with the RN's Flag Officer Sea Training organisation preparing for their looming first deployment since refit.

The ship and sailors have been put through their paces, tested in the arts of war, peace, peacekeeping and disaster relief as well as the expected battle exercises.

The series of tough tests put everyone aboard under stress and are designed to ensure they are ready to react under any circumstance to changing missions and circumstances.

On one day they were practising disaster relief after a civil emergency, another evacuating citizens from a trouble-stricken city. The weekend before the Seawolf firing Iron Duke was hosting dignitaries and schoolchildren as a way of promoting UK interests worldwide.

Picture: PO(Phot) Donny Osmond, FRPU East



## £1½bn investment in Sea Skua successor

HEADING towards its target at just under the speed of sound, this is the Navy's future anti-ship missile which has received a £500m investment.

Carried into battle by the Fleet Air Arm's new Wildcat helicopters, this is the successor to the battle-proven Sea Skua which has served its Lynx well for more than 30 years.

This is FASGW – Future Anti-Surface Guided Weapon, pronounced *fas-gee-double u* – in which the governments of Britain and France have agreed to invest for their respective military forces.

Whitehall will pump £280m into the project to develop the missile which is being designed and built by MBDA, the international defence firm also behind the Sea Viper missiles on the Royal Navy's Type 45 destroyers.

The new anti-ship missile is designed to sink small to medium-sized foes (up to corvette size, so similar to our River-class patrol ships) and damage larger warships.

Packing a 30kg (66lb) warhead, the new missile will be around 2.5m long (8ft 2½in) with its speed predicted to be 'high subsonic'.

It's also been specifically designed to deal with fast attack craft – threats which generally didn't exist when Sea Skua was in development – and will be guided on to its target by an infra-red seeker and a two-way data link with the Wildcat observer.

The investment in the weapon will support around 200 highly-skilled jobs in the UK at MBDA's sites in Lostock near Manchester, Bristol and Stevenage. The contract will also protect a further 200 jobs in France.



WE ARE IN IT  
**TOGETHER**

**ssafa**  
Lifelong support for our Forces and their families

SSAFA provides lifelong support for our Forces and their families.  
To find out more  
**0845 130 0975**  
**ssafa.org.uk**

Registered Charity No. 210760 and SC0389056. Est. 1895.



## Tribute to a veteran

MARKET Harborough branch veteran S/M Geoff Smith, who survived the sinking of HMS Spartan during the Allied landings at Anzio in World War 2, has died at the age of 88.

Geoff was an 18-year-old electrician on board Spartan when the cruiser was bombed during Operation Shingle.

He was among the last surviving sailors from the 500 brought out alive.

S/M Geoff was drafted to HMS Aurora after Anzio, where his senior officer was the late actor Kenneth More.

He went on to receive a mention in dispatches for capturing 16 German prisoners during an operation on the Greek island of Levita.

For the past 16 years, Geoff had visited Anzio to remember his fallen shipmates.

The Mayor of Anzio said: "Geoffrey has been a hero of the last century and will be remembered by the city."

Geoff leaves Betty, his wife of 68 years, a daughter and a son, grandchildren and great-grandchildren.

He will be sadly missed by all his friends and shipmates in Market Harborough and Wigston branches.

## Tub for sale

HORSHAM branch have a Rum Tub for sale.

Shipmates say it requires "a bit of refurbishment" and they would like to sell it for £100 and it would have to be collected.

Anyone interested in the tub should contact S/M John Dale on 01403 262129 or email [jjd93@sky.com](mailto:jjd93@sky.com)

↓ RNA HQ, Room 209, Semaphore Tower (PP70), HM Naval Base, Portsmouth PO1 3LT.  
↓ [admin@royalnavalassoc.com](mailto:admin@royalnavalassoc.com)  
↓ 023 9272 3747  
↓ [www.royal-naval-association.co.uk](http://www.royal-naval-association.co.uk)

# 'Our gift to the Naval Service'

## CONA 'is on the up'

THE new monument taking shape at the National Memorial Arboretum is the RNA's gift to the Naval Service, according to the organisation's General Secretary.

Capt Paul Quinn said some groups believed the glass-and-stone memorial was dedicated to the RNA – but that is not the case.

And he added that he would like to see as many representatives of the wider Naval family at the arboretum as possible to mark the dedication of the memorial next month.

Association officers are excited by the prospect of unveiling what they firmly believe is an innovative and eye-catching design.

The unveiling and dedication at the arboretum in Alrewas, Staffordshire, is on Sunday June 15, placing it at the heart of the RNA's annual conference, which this year is being staged at the Britannia Royal Court Hotel near Coventry.

"It is not an RNA memorial – we are the main sponsor and we have made it happen, but is a gift to the Naval Service from the RNA on the occasion of the 60th anniversary of our Charter," said Capt Quinn.

"It has also been made possible through generous donations by the Gosling Foundation and the RNRMC."

The dedication will be a high-profile event, with royal representation and a number of senior Royal Navy officers and politicians attending. Mayors from Naval communities and commanding officers representing all the fighting arms of the Naval Service have also been invited.

As such, Capt Quinn is keen that shipmates should plan their visit well in advance and ensure they are in position in plenty of time to avoid disappointment.

"The service starts at 12 o'clock sharp, and there will be a parade beforehand," said Capt Quinn.

"The parade will consist of the Royal Marines Band CTCRM and a guard from HMS Forward, who will parade the Royal Naval Reserve Colour.

"Anyone marching in the parade has to be in place at the Armed Forces Memorial by no later than 11.20am, and preferably earlier.

"There will be a separate rehearsal for

standard bearers, who should muster at the new memorial at 10.30am."

Capt Quinn said they would welcome any Navy-related standards – including those representing the Merchant Navy – in the parade, which he added will take their places at the new memorial in some style.

The parade will include contingents of Phase 2 trainees from HM ships Collingwood and Sultan, and Sea Cadets from Warsash unit, near Southampton.

Those not parading are invited to make their way directly to the memorial where areas are marked out for spectators.

Capt Quinn said there would not be many seats, except those for VIP guests and those with reduced mobility.

"There are only 100 seats in total, so any shipmates needing one must contact RNA HQ in advance – and the minimum requirement is a Blue Badge," he said.

"Spectators need to be in position by 11.40am, which is when the parade steps off.

"The service should last 40-45 minutes." Shipmates attending the National Conference, will be brought from their Coventry Britannia hotels to the arboretum by coach – coaches park for free, but car parking for other visitors costs £3, with free entry to the arboretum.

The hotel is also the venue for a Sunday evening bash, to which all are invited – though they need to book directly with the hotel in advance; contact Nigel at RNA HQ for the contact number.

Capt Quinn said groundwork for the memorial has started on a site formerly occupied by the Defensively Equipped Merchant Ships memorial – and he added that the RNA was grateful to the DEMS Association for agreeing to the move.

The reconfigured DEMS memorial now stands close to the Merchant Navy Convoy plantation.

The glass panels for the Naval Service Memorial will be installed in the second or third week of this month, and sculptor Graeme Mitcheson has almost completed detailed work on the Kilkenny limestone naval figure, with head bowed (pictured right at Graeme's workshop), which will stand around two metres tall to one side of the memorial's paving.



CONA – the Conference of Naval Associations – has enjoyed steady growth since it was formed in 2012, according to RNA Assistant General Secretary S/M Andy Christie.

Membership is steadily increasing and the organisation now features 27 member Associations, large and small.

The Second Sea Lord has been appointed as President of CONA, and the website has gone live at [www.cona.org.uk](http://www.cona.org.uk)

The website includes news from member associations and, most importantly, it contains the first register of all Naval associations – or does it?

Do you know of any associations not in the register?

Please contact the CONA Secretary – details below – if your association would like to be included.

CONA has played a key role in ensuring that representation from all parts of the Naval Service and Naval associations will be in attendance at the dedication of the Naval Service Memorial at the National Memorial Arboretum in Staffordshire (see left).

So why should your association join CONA?

- ✓ Membership benefits include:
  - ✓ Information cascades from the Royal Navy, Veterans UK, Veterans Scotland and others;
  - ✓ Discounts and one per cent of turnover return from the UK Holiday Group;
  - ✓ Discounted BUPA Veterans medical insurance;
  - ✓ Discounted HMCA medical insurance;
  - ✓ Discounted Wessex Funeral Services'
- ✓ A chance to get together with like-minded associations, twice a year, since they are stronger talking and working together.

CONA is a loose-knit group, with individual associations retaining their own identity and autonomy, and with the only governance being the re-election of the chairman, chairman working group and CONA secretary annually.

Oh – and best of all, it doesn't cost anything.

It is absolutely free.

If your association is interested in joining CONA please visit the website [www.cona.org.uk](http://www.cona.org.uk) or contact CONA secretary Andy Christie on 023 9272 0782 or [andy@royalnavalassoc.com](mailto:andy@royalnavalassoc.com)

## £50 PRIZE PUZZLE



THE mystery ship in our March edition (right) was frigate HMS Aurora, named after the Roman goddess of the dawn, and Mr J Hughes, of Prestwood, Bucks, wins our £50 prize for identifying her.

This month's ship (above) was another frigate, and like most of her sisters saw action in the Falklands Conflict.

Launched by Vosper Thornycroft in late 1972 and commissioned in the summer of 1977, this ship was bought by Pakistan in 1994 and still serves her new owners today.

(1) What was her name while in the RN, and (2) what is her Pakistan Navy name?

We have removed the pennant number from the image.

Complete the coupon and send it to Mystery Picture, Navy News, Navy Command, Leach Building,



HMS Excellent, Portsmouth PO2 8BY. Coupons giving the correct answers will go into a prize draw to establish a winner. The closing date for entries is June 13.

More than one entry can be submitted but photocopies cannot be accepted. Do not include anything else in your envelope: no correspondence can be entered into and no entry returned.

The winner will be announced in our July edition. The competition is not open to Navy News employees or their families.

### MYSTERY PICTURE 231

Name .....

Address .....

My answers: (1) .....

(2) .....

## New institute will focus on veterans

UP to a fifth of the population of the UK may benefit from a new university institute which focuses on researching the needs of veterans and their families.

Anglia Ruskin University's Veterans and Families Institute will support the needs of ex-Servicemen and women and their loved ones, lobbying the government for change and bringing together the

country's experts in mental health and social care.

The Institute was formally launched last month with a conference and a network event, attended by more than two-thirds of the universities involved in veterans research activities.

↓ [www.anglia.ac.uk/ruskin/en/home/microsites/veterans\\_and\\_families\\_institute.html](http://www.anglia.ac.uk/ruskin/en/home/microsites/veterans_and_families_institute.html)



## Salute to Fleet Air Arm field gunners

THE Royal Navy's top officer paid tribute to the fighting spirit of Fleet Air Arm Field Gun crews over the decades as he rededicated the Ladysmith Suite at RN Air Station Culdrose.

First Sea Lord Admiral Sir George Zambellas unveiled a plaque dedicated to the 'Men of Air' in the Warrant Officers and Senior Rates Mess.

More than 80 'Old and Bold' FAA Field Gunners gathered for a ceremony that reflected a proud history and legacy stretching back to 1947, when the green of the FAA entered the historic Inter-Command competition.

The origins of Field Gun lies in the Boer War when sailors of the Naval Brigade used heavy Naval guns from HM ships Powerful and Terrible against Boer troops to relieve

the besieged garrison at Ladysmith between 1899 to 1900, at one stage manhandling their makeshift field guns over rough terrain.

On their return to England the men and their guns were paraded through London.

The Inter-Command Field Gun competition was run from 1907 and became one of the highlights of the Royal Tournament until the 'Last Run' in 1999.

"We are really grateful that the First Sea Lord could be here to honour the occasion," said Daisy Adam, former trainer in 1993 and 97 who ran six times from 1979 (including the Last Run), and is Chairman of the FAA Field Gun Association.

"It's a fitting place for the history of FAA Field Gun to be as we moved from our long

-standing headquarters at HMS Daedalus near Portsmouth after it closed in 1995.

"For the last four years we trained and ran from Culdrose."

The new bar area has been fitted out with memorabilia, artefacts and pictures they gathered from personal collections and museums across the Naval Service, with special thanks to Max Orkamfat from Culdrose Graphics' studio and his team for their work producing the presentation board.

Bringing the ceremony to a close the First Sea Lord happily posed for a group photograph with the Green Jackets while they sang the traditional FAA Field Gun anthem *Bread of Heaven*, complete with a unique 'Men of Air' twist (above).



Secure communications  
you can depend on



# Save time and money travelling to meetings

With our enhanced Video TeleConferencing (eVTC) service you can quickly meet with colleagues from across the Armed Forces and securely share videos and documents without the need to travel.

Find out what we can do for you:  
0800 389 2272 option 8  
[dfts.comms@bt.com](mailto:dfts.comms@bt.com)  
[www.dfts.r.mil.uk](http://www.dfts.r.mil.uk)  
[bt.com/defence](http://bt.com/defence)





# A Formidable warrior

**FRIDAY, May 4 1945 and the differing fortunes of two Royal Navy carrier task groups.**

In the Arctic Circle, the final carrier operation of the war in Europe would drive another nail in the coffin of the U-boat arm (see below).

But half a world away the flat-tops of Task Force 57 – better known as the British Pacific Fleet and, by its somewhat exasperated men, ‘the Forgotten Fleet’ – were engaged in a mortal struggle against men for whom life mattered not.

Five carriers were committed as part of the force providing aerial support to Operation Iceberg, the invasion of Okinawa: *Illustrious*, *Indomitable*, *Indefatigable*, *Victorious*, *Formidable*.

The island was the last outpost of Japan before the mother islands – and was correspondingly defended to the last man.

In the first month of the operation, the Japanese had thrown some 1,100 suicide planes – *kamikaze* – at the British and American fleets mustered off the Ryukyu Islands.

*Indomitable* and *Indefatigable* had been hit and damaged by the suicidal enemy pilots on April 1. *Illustrious* was damaged by a near miss a few days later and, having earned her final battle honour, bowed out to be replaced by her sister *Formidable* (pictured above right in her 1944 camouflage paint scheme).

After a spell of rest, recuperation and resupply in Leyte in the Philippines, the British carriers returned to the fray on May 1 off the Sakishima Gunto, a cluster of islands a good 200 miles to the southwest of Okinawa.

It was May 4 before the ships were in position to begin their assault.

The targets this Friday were the airfields on the island of Miyako, subjected to a bombardment from the 14in guns of HMS King George V and Howe, with

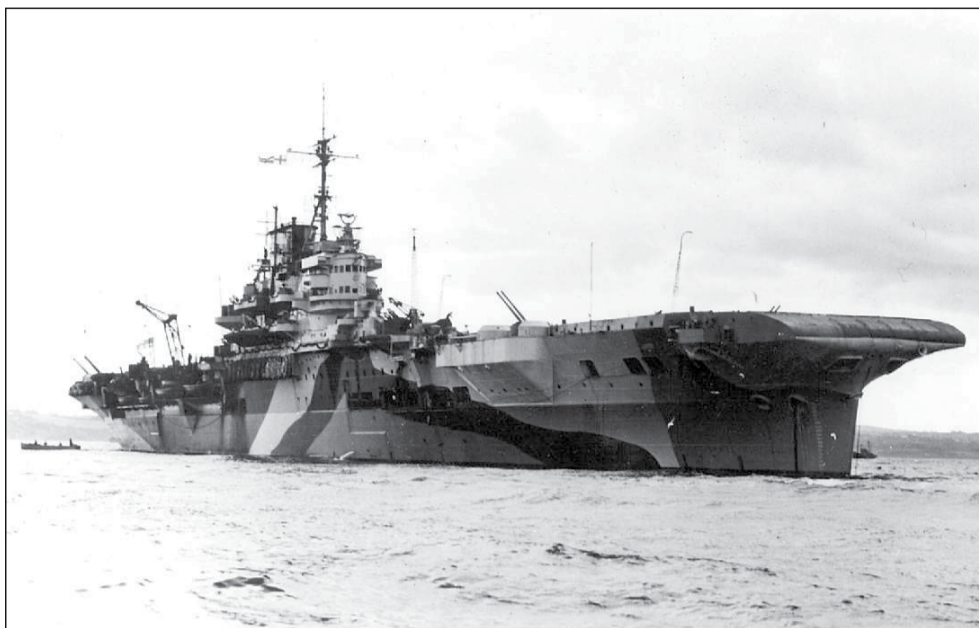

the aircraft of the Fleet Air Arm providing an aerial shield for the force – and spotting the fall of shells from the battleships.

All of which brought the British Pacific Fleet well within range of Japanese air power – and the fliers of the *Rising Sun* responded.

The ships came under what were described as “sustained” *kamikaze* attacks – and threw up a veritable wall of fire and iron: machine-guns, Oerlikons, pom-poms, 4.5in shells, Bofors.

The sky filled with flashes of orange and yellow and small black flak clouds.

In this hellish inferno of fire, smoke and noise, friend and foe became all but indistinguishable as they darted around the ships; at least one Hellcat fighter fell victim to *Formidable*’s defensive barrier.

Not so one Japanese Zero, which made a fast, low-level pass over *Formidable*, parallel with her flight deck, then climbed abruptly

before it turned, and plunged on to the carrier’s stern, the bomb it carried either exploding on impact – or being dropped a split second before. Whichever, a fireball engulfed *Formidable*’s midships.

Eight men were vaporised or incinerated – including the unfortunate crew of an Avenger torpedo-bomber manoeuvring on the deck. Six times that number were wounded. Eleven aircraft were wrecked, while shrapnel pierced the flight deck, entered the hangar and damaged the boiler room, reducing *Formidable*’s speed to 18kts.

The aftermath of the *kamikaze* attack has provided historians with some of the most famous images of the war in the Far East: towers of black smoke and columns of white steam rising from the stricken leviathan; hooded flight deck parties staring at a twisted mangle of aircraft next to the carrier’s island as fire teams douse the wreckage;

waters until the war’s end – and remain a thorn in the empire’s side.

On August 9 – six days before the Japanese surrender – her aircraft struck at airfields around Onagawa, 200 miles north of Tokyo to keep any *kamikazes* in check.

On their return journey, the aircraft attacked the destroyer *Amakusa*. The attack’s leader, Canadian Lt Robert Hampton ‘Hammy’ Gray, hit the ship with two 500lb bombs before he was brought down by flak.

The *Amakusa* sank. Hampton Gray earned a posthumous VC – the last of WW2, and the last (to date) to be awarded to a member of the Royal Navy.

The last act of *Formidable*’s career was to help ferry former prisoners of war home – a mission which kept her busy for 14 months.

Thereafter she was placed in reserve and finally put up for sale in 1953.

It was her war damage which sealed her fate – in the age of post-war austerity, the government decided rebuilding her for the new Cold War era would prove too much.

Whilst the *kamikaze* attacks had not done for *Formidable*, they had compounded earlier damage suffered in the Mediterranean. Like much of the Fleet, she was mauled off Crete in May 1941 – in *Formidable*’s case, two 1,000lb bombs which knocked her out of the war for six months.

Crete was the second of ten battle honours the carrier earned, the fifth (and as yet final) ship in a lineage going back to the mid-18th-Century.

Once repairs in Norfolk, Virginia, were completed, ‘the ship which launched herself’ (she had accidentally headed down the Belfast slipway ahead of her official launch) returned to the Mediterranean theatre providing air support for the landings in North Africa, Sicily and finally



The Saintes.....	1782
Matapan.....	1941
Crete.....	1941
Mediterranean.....	1941
East Indies.....	1941
North Africa.....	1942-43
Sicily.....	1943
Salerno.....	1943
Norway.....	1944
Okinawa.....	1945
Japan.....	1945

Class: *Illustrious-class* Fleet carrier

Pennant number: 67  
Builder: Harland & Wolff, Belfast

Laid down: June 17 1936  
Launched: August 17 1939  
Commissioned: November 24 1940  
Decommissioned: August 14 1947

Displacement: 23,000 tons  
Length: 740ft (225.6m)  
Beam: 95ft 9in (29.2m)  
Draught: 28ft 10in (8.8m)  
Speed: 30 knots

Complement: 1,229  
Propulsion: 3 x Parsons geared steam turbines driving 3 x shafts (110,000shp)

Armament: 6 x 8 x two pounder ‘pom-poms’;  
2 x 4 x 40mm Bofors flak;  
4 x 1 x 40mm Bofors flak;  
10 x 2 x 20mm Oerlikon flak;  
14 x 1 x 20mm Oerlikon flak  
Aircraft: 36-54

mainland Italy.  
In the summer of 1944 she was in Arctic waters for carrier strikes against Tirpitz in the Norwegian fjords.

## IWM PHOTOGRAPHIC MEMORIES

THIS is the apotheosis of Royal Navy carrier strike, 1945 style.

Columns of water are thrown up around the former North Sea ferry *Black Watch* as Fleet Air Arm Avenger bombers deal a final blow to the mauled German U-boat arm.

This was the final carrier operation of the war in Europe – indeed the last carrier operations in European waters until the Adriatic in the 1990s, Operation Judgement.

Judgement had been delivered before – brutally and brilliantly, with the crippling of the Italian battleships at Taranto.

So perhaps it was fitting that the codename was resurrected for this last attack.

For even with the Russians on the Elbe, Hitler dead and Berlin in Soviet hands, convoys between Britain and the USSR, providing aid and military equipment were still running; RA66 was inbound for the Clyde from the Kola Inlet as escort carriers HMS *Searcher*, *Trumpeter* and *Queen* mustered off the Norwegian coast to deliver Judgement.

Over the winter of 1944-45, the bay at Kilbotn, a hamlet on the western shores of the Vågsfjord, half a dozen miles south of Harstad, had become the hub of German submarine operations in the Arctic.

Sheltering at Kilbotn this Friday was the *Black Watch*, commandeered by the Nazis when they invaded in 1940 and turned into a depot ship to support U-boat operations, plus a small steamer, the *Senja*.

And making use of this floating submarine ‘base’ this fourth day of May, U711.

In a dozen patrols over a two-year

period, its commander Hans-Günther Lange had sunk just one Norwegian fishing boat and the corvette HMS *Bluebell* (lost with all bar one hand).

This Friday afternoon, most of Lange’s men were aboard the *Black Watch* to which U711 was moored; a skeleton crew, including the skipper, were manning the boat. In the space of just seven minutes, their world would change irrevocably – or end.

More than 40 Avengers and Wildcat fighters appeared over Kilbotn – the Wildcats to suppress the base’s air defences and keep the Luftwaffe at bay.

As it was, German fighters at nearby Bardufoss did not respond, but the flak gunners did, downing one Wildcat and one Avenger with the loss of four aircrew.

German losses, however, were much heavier. The *Black Watch* and *Senja* were sunk and U711 mortally wounded; her skeleton crew tried to sail her away from Kilbotn but abandoned the attempt. The submarine sank later that day, while most of her crew died in the doomed *Black Watch*. In all around 150 Germans were killed.

Though a gleaming success, with hindsight it would turn out that Judgement was unnecessary; a few hours before the raid, Admiral Dönitz – not just head of the German Navy, but now Hitler’s successor – had ordered his boats to cease their attacks on Allied shipping (although not all submarines received the instruction).

■ This picture (A 28656) – and 9,999,999 others from a century of war and peace – can be viewed or purchased at [www.iwmcollections.org.uk](http://www.iwmcollections.org.uk), by emailing [photos@iwm.org.uk](mailto:photos@iwm.org.uk), or by phoning 0207 416 5333.





H.M.S. DEFENDER

# RIFT

## JOIN FORCES TODAY!

WE SPECIALISE IN

# TAX REFUNDS FOR ARMED FORCES



If you drive your own vehicle to base and have been posted to different bases (including outside the UK), there's a good chance the taxman owes you a **£2,500** refund. You may also be able to claim for Mess Dress. As the UK's leading tax refund experts,

we know exactly what you can and can't claim for. Home to Duty Travel (HDT) or Get You Home Travel (GYH) allowances are non-taxed, so if you receive these we deduct them before any refund is claimed.

**Join forces with RIFT - get your free assessment TODAY!**

- ✓ **£2,500 tax refund**  
(avg based on 4 yr claim)
- ✓ **No forms**

- ✓ **No upfront costs**
- ✓ **No refund, no charge**

It's **PAYBACK TIME** visit [riftuk.com/MOD](http://riftuk.com/MOD)

✉ email us [info@riftuk.com](mailto:info@riftuk.com)

☎ Call us on 01233 628648

✉ Text RIFT to 80010

**We're here when you need us:** Mon to Thurs 8.30am - 8.30pm Fri 8.30am - 6.30pm Sat 9.00am - 1.00pm

Details of the legislation RIFT claim under can be found on [www.HMRC.gov.uk](http://www.HMRC.gov.uk) under section 336-339 of ITEPA 2003. We operate under this legislation to ensure that no one is exposed or receives a refund they are not entitled to.



# AYE ROBOT



**CHARGING** past the Gosport waterfront at nearly 30kts, this could be the forerunner of the minehunter of tomorrow.

A minehunter doing 30kts?

Yes, really.

And that's just the beginning. For a few months from now, the sailors in this photograph will be removed from the picture – and motor boat Hazard will be driven around by remote control.

Yes, really.

And the remote-controlled Hazard will be launching mini submersibles of her own, roaming beneath the surface of the sea, looking for and, should they find one, destroying mines.

Yes, really.

It's not science fiction. It's a technological fact.

It's down to a specialist team

of sailors in Portsmouth Naval Base to turn what technology can do into naval practicalities.

The Maritime Autonomous System Trials Team (MASTT), the small Portsmouth-based Royal Navy unit testing the new equipment, say it's not a question of 'if', but 'when' their unmanned systems will be used in the front line – as they demonstrated to Britain's senior sailor, First Sea Lord Admiral Sir George Zambellas, last month.

Metre for metre the current breed of Sandown and Hunt-class minehunters are the most expensive vessels in the Fleet.

And in the case of the Hunts, they're also getting long in the tooth (the youngest, HMS Quorn, is 25 years old, the longest-serving, Ledbury, 35 years old).

The future Mine Counter

Measures and Hydrographic Capability programme is not only looking at the next generation of minehunting, but also surveying (motor launch Gleaner, for example, is also more than 30 years old) – with the emphasis very much on automation.

The family of equipment MASTT is putting through its paces is headed by Hazard, small, fast and able to be transported by an RAF Hercules.

The boat carries either the bright yellow torpedo-sized Remus 600 or the much smaller Remus 100, which are sent off to scan the seabed at depths of up to 600 and 100 metres respectively.

Both versions of Remus are tried and tested technology, in use with RN dive teams and minehunters for nearly a decade (it was used extensively during the Olympic security operation).

The smaller Remus is 1.6m (62in) long and weighs 37kg (81lb) – or about one and a half times your luggage allowance on a typical international flight.

The larger 600 version is slightly longer, but slightly lighter, than a Stingray torpedo – and bimbbling around in the water on its survey/hunt mission, it certainly looks like one.

At present they are launched manually, disappearing for hours at a time as their side-scan sonars 'ping' the seabed, sending regular updates on their location back to mother (but not the data – that ability doesn't exist).

Its run done – and having scanned far more of the ocean floor than a conventional minehunter could achieve in the same time – Remus returns to the surface, is recovered (again, manually), the data it has collected is downloaded and analysed by the Royal Navy's mine warfare experts.

They then send in another small submersible, steered on to a contact and identified by a mine specialist using its onboard camera. (In the front line it would carry an explosive charge to destroy any mines, like the Seafox system used by our minehunters off Libya and in the Gulf.)

"What you can do with 40 men and women in a minehunter, here you can do with two or three sailors – and in a fraction of the time," said CPO 'Fingers' Dumbleton, who's spent more than 20 years in the mine warfare branch.

"It's great that the Navy is taking a step in the right direction, looking at the technology out there, and seeing where we can use it in the future."

The goal in the future is to fit this technology and unmanned sweep systems to a Hunt-class ship, but the system could easily be run from any reasonable-sized warship, sent anywhere in the world in just 48 hours.

They will sit safely on the ship, or in a base ashore, and send unmanned surface vessels and their remote systems – several Remus could be deployed simultaneously – hunting mines or gathering hydrographic data.

From the hunt viewpoint, an automated 'family' of 'mother ship' plus an assortment of hi-tech remote-controlled and robot submersibles crucially takes the 'sailor out of the minefield' – RN minehunters have been in harm's way from the Great War up to the clearance of the Khawr Abd Allah in Iraq in 2003.

But the automation does not take the sailor out of the equation.

Mine warfare and hydrographic survey experts will still be required to pore over the masses of data collected by Remus on its underwater travels.

"We are not taking sailors out of the equation," explains Lt Cdr Jack McWilliams, Officer in Command of MASTT.

"You will still need individuals



● CPO 'Fingers' Dumbleton (left) and a MASTT shipmate prepare to put a Remus 100 in the Solent on a test run and (below) a Remus scan of a wartime LST sunk in Lyme Bay during D-Day rehearsals in 1944

Pictures: LA(Phot) Nicky Wilson, FRPU East



with specialist mine warfare and hydrographic skills, a human being to identify a contact, but they will be much safer, and this is a much more effective way of doing our job.

"The technology is proven. We're taking it into the military realm. This will be the seafaring equivalent of the unmanned aircraft which have revolutionised aerial warfare.

"This technology is fantastic –

and we are right at the forefront of it. It is the future."

The manned concept of the project undergoes further testing this year in exercises around La Spezia in Italy and Brest in France.

And if plans to convert one of Portsmouth's flotilla of Hunt-class ships receive the green light, unmanned surface vessels could be operating from one in a couple of years' time.

## HMS COLLINGWOOD OPEN DAY

Sponsored by **8 WEALTH MANAGEMENT**

Featuring **The RNRMC Field Gun Competition**



**Saturday  
31 May 2014  
0930 - 1700**



Tickets	Adult	Child OAP	Family (2+3)
Advance	£6.00	£4.00	£17.00
On the day	£8.00	£5.00	£21.00

Advance tickets:  
Gosport & Fareham Tourist Information Offices  
and News Offices  
[www.royalnavy.mod.uk/Collingwood-Openday](http://www.royalnavy.mod.uk/Collingwood-Openday)





# Clock ticking for carrier

LESS than three months to go, and still HMS Queen Elizabeth remains tantalisingly hidden from full view.

The first of the Royal Navy's two super-carriers is structurally almost complete, and workers at the Babcock yard in Rosyth are preparing for a 'topping out' ceremony of sorts – although normally used when talking of buildings, the addition of the lower part of QE's pole mast means she is within a few feet of her full height.

And because of that height – 56m from keel to mast top – the pole mast has been built to fold down (forwards) to allow her to pass under 'low' bridges.

Her forward aircraft lift, capable of handling a Chinook or two F-35 Lightning IIs, is in place, and the aft lift is ready to be fitted.

Her radar mast is also in place – an installation that seems so big on a Type 45 destroyer but which sits diminutively atop the squat forward island on the starboard side of the flight deck.

Approaching the ship in her dry dock, the massive overhang of the sponsons along her hull hint at her sheer bulk – so much so that cameras will be used to help those on the bridge guide her alongside a jetty.

The First Lieutenant is reportedly delighted at the depth of the overhang – no more divisions cancelled because of the weather as the ship brings her own shelter with her...

And some ports familiar to those who sailed in Invincible, Illustrious or Ark Royal will no longer be open to the nation's flagship; another adjustment will mean getting used to mooring in deeper water and using boats to get to and from shore, just as the Americans have been doing for decades.

The Queen will name the super-carrier in a ceremony at No. 1 Dock on July 4.

Currently QE's bow is still shrouded in scaffolding, so the many visitors to the north bank of the Forth near Dunfermline are still denied the sight that will stop first-time viewers in their

tracks. Instead visitors are ushered into a cavernous hangar more than two decks high, still crammed with temporary buildings and stores but jaw-dropping nonetheless – there is enough floor space here to park two Type 23 frigates side-by-side with plenty of room to spare all round (pictured).

The same goes for the flight deck – even though QE will displace around two-thirds of the giant American carriers, her flight deck is only 20 per cent smaller, and is enormous compared with the Invincible class.

And it is because the new ships are second only to the Americans in scale that so much preparatory work is being done with the US Navy – the Royal Navy is reviving skills that have lain dormant since the fourth HMS Ark Royal decommissioned in 1979.

Of course, technology has moved on since the 1970s, and Queen Elizabeth will sail with a ship's company slightly smaller than an Invincible-class ship, which in itself requires new approaches.

For example, the QE-class will be equipped with alarms which can be activated if a sailor injured him or herself in a fall – in some compartments or corridors in the ship there might be no one passing for several minutes, if not hours.

Temporary visitors may require computer-generated guidance to get around the ship – similar to the temporary QR codes on her walls and bulkheads which shipyard staff use to guide them round (particularly useful when a corridor or compartment may be closed off for major construction work, requiring an unusual detour).

The bridge is surprisingly small for such a large ship – in part because flying operations will now be controlled from the aft island rather than a Flyco room behind the bridge.

And even more surprisingly, if you stand in the middle of the bridge, you are not over the hull itself but over the sea, such is the degree to which the flight deck spreads out to port and starboard.

Plans to beam live coverage of take offs and recoveries to screens

temporary wooden 'offices' still hold sway, allowing construction staff to hold ad hoc meetings without needing to troop off the ship to a shoreside office (and thereby saving valuable time).

Accommodation spaces that are being fitted out give a better sense of how life on board will feel – they are warmer and brighter,

lift will be installed, the propeller shafts completed, the integrity of the hull tested to prevent water coming in and, equally importantly, the ship will be painted the Royal Navy's trademark grey – she's currently a mix of blue, grey and a reddish brown.

Hand-in-hand with this work, the ship's company are testing the various systems and equipment on board so they can write the operating manual for when the carrier goes to sea for the first time in 2016.

In addition, they've also got to help with the planning for the naming ceremony.

Aside from the Queen, the July 4 event will be attended by 500 VIPs, plus at least 1,000 workers involved in the construction, and the carrier's affiliates; the ship is twinned with the capitals of England and Scotland.

"It's going to be busy because we'll be preparing for the event, but also continuing with our work learning about the ship and her systems to develop our operating procedures," said POET(WE) Steph Simpson, who is helping to test the ship's unique automated weapon handling system.

"The countdown to the naming ceremony is an exciting landmark – it means that we're not far from achieving one of the most important milestones in the ship's life.

"And, personally I feel honoured to be involved in such an historic day for the Navy, and for the country."

Because of the way Queen Elizabeth has been constructed – huge sections built at half a dozen yards around the UK, then pieced together in Rosyth in a specially-enlarged dry dock – there will be no traditional slipway launch.

Instead the sluices will be opened to allow the waters of the Forth to pour in and lap around the 280-metre-long (920ft) hull for the first time.

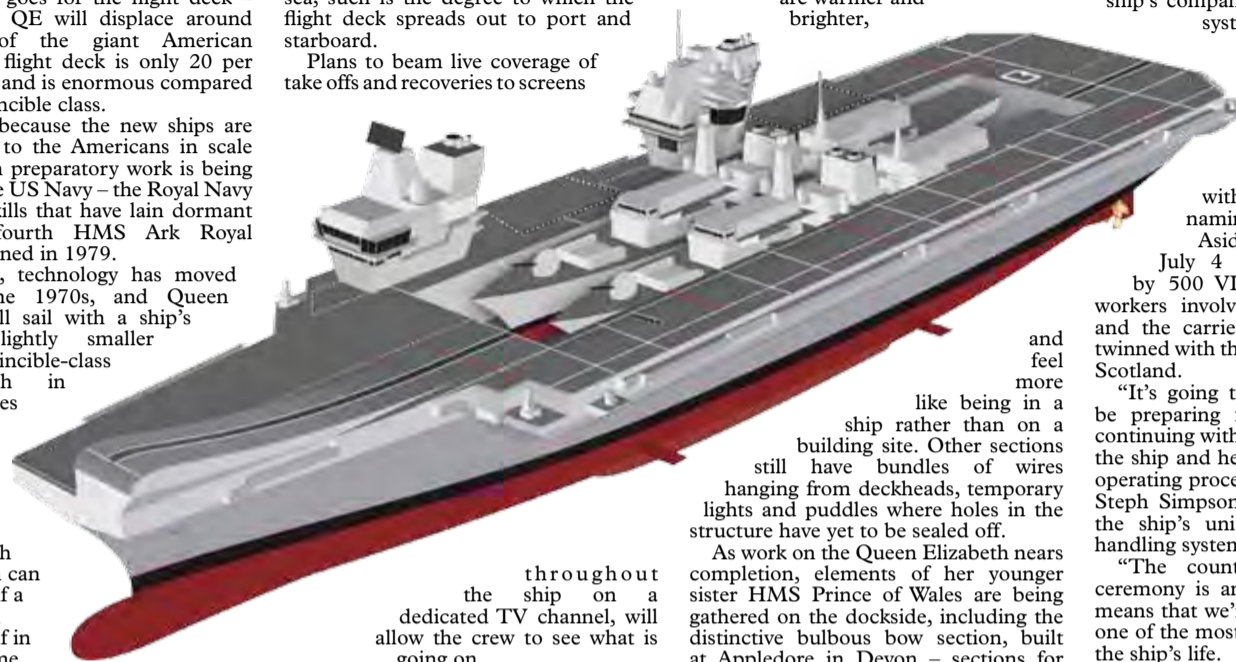

and feel more

like being in a ship rather than on a building site. Other sections still have bundles of wires hanging from deckheads, temporary lights and puddles where holes in the structure have yet to be sealed off.

As work on the Queen Elizabeth nears completion, elements of her younger sister HMS Prince of Wales are being gathered on the dockside, including the distinctive bulbous bow section, built at Appledore in Devon – sections for both carriers have been built at Aircraft Carrier Alliance yards around the UK and floated to Rosyth for final assembly.

With the 100-day milestone date now passed, the 95-strong ship's company and some 3,000 dockyard engineers, fitters and technicians are acutely aware of what needs to be done to ensure the 65,000-tonne leviathan is ready for her launch.

Between now and July 4 – three days shy of the fifth anniversary of the carrier being laid down – the second aircraft

throughout the ship on a dedicated TV channel, will allow the crew to see what is going on.

Two big screens will also be installed to show which aircraft are out and when they are due back – not a million miles away from airport departure boards, but there to keep flight deck crew up to speed with flying operations.

Some compartments are nearer to completion than others – the reception desk in the ship's medical centre has the familiar look of a modern GPs' complex and the operations room is taking shape, while in other spaces

## Gain the recognition you deserve



Work, learn and qualify

[www.port.ac.uk](http://www.port.ac.uk)

Consolidate your expertise and experience into a higher education degree in Leadership and Management.

- Staged awards of Postgraduate Certificate, Diploma and MSc – each taking a year to complete
- Fast-track to Diploma or MSc stage depending on rank, experience and qualifications
- Work-based part-time distance learning requiring minimal attendance
- University of Portsmouth is an ELC approved supplier and has delivered courses to Armed Forces personnel for many years

For more information:

T: +44 (0)23 9284 2991  
E: [pbs-studentrecruitment@port.ac.uk](mailto:pbs-studentrecruitment@port.ac.uk)  
W: [www.port.ac.uk/armedforces](http://www.port.ac.uk/armedforces)





● Three new features at the National Museum of the Royal Navy: (l-r) the giant touch screen 'interactive timeline'; the 'artefact wall'; and the er

# The past is no

**11** AM on Wednesday, August 5, 1914 and through the squalls dogging the southern North Sea half-way between the shores of England and Holland, smoke was sighted on the horizon.

The ships of the 3rd Destroyer Flotilla had responded to reports from fishermen of a vessel "dropping things overboard".

The 'things' were mines, laid by the former North Sea steamer Königin Luise that very night, the first of the nascent war between Britain and Germany.

In minutes, HMS Lance had closed the range to within five miles. One of her three 4in hurled a shell in the direction of her prey – the first round fired by any British gun in what would become the Great War.

A century later and that same gun, restored to its original state, stands guard at the entrance to new galleries in the National Museum of the Royal Navy – part of an £11.5m investment in the Portsmouth area so the Royal Navy's story throughout the 20th Century to the present day can be fully told.

Some £4.5m has been pumped into the museum in the historic dockyard, while across the water in Gosport £7m has been spent bringing HMS Alliance back to life after suffering decades of abuse by pigeons (and their droppings), not to mention the toll the elements have taken on Britain's only WW2-era submarine.

The massive investment in understanding the Royal Navy's recent history is aimed at nearly doubling visitor numbers at the submarine museum, while more than 700,000 people are expected to pass through the

gates of the historic dockyard this year.

Its 'Hear My Story' galleries draw on accounts, photographs, films and mementos and artefacts from more than 1,000 sailors and Royal Marines to describe life and death in the Senior Service since 1900.

In addition, the museum is also opening the first of a series of temporary exhibitions marking the role of the Royal Navy in World War 1.

It has never before had the space to display objects such as the poignant personal chest – containing all his worldly and naval possessions – of a cadet who died of scarlet fever in Gibraltar in 1911 at the age of 17; the sword of Vere Harmsworth – son of *Daily Mail* owner Lord Harmsworth – who died fighting with the Royal Naval Division on the Somme; and a 'Blair-Bush' world domination tour 2003' T-shirt as worn by Royal Marines in Iraq.

Most of these items feature in display cases. Larger items are fixed to an 'artefact wall' (it's a wall covered with historic artefacts...).

There's a canoe identical to those used in the 'Cockleshell Heroes' raid; the board erected by the Germans to commemorate the storming of the tanker Altmark by British 'sea pirates'; and a motorbike used by a Taliban insurgent intent of inflicting carnage with a suicide bomb – until he was rugby tackled by Royal Marine Sgt Noel Connolly.

The museum has also been keen to show the impact of the Senior Service on everyday life in the UK – 'the Navy brand': cigarettes, films and a good smattering of toys and games such as Airfix's Super Flight Deck (launch and land a Phantom jet in your living room) and an Action Man sailor 'with

realistic hair and beard' (which is so much more exciting than special powers...).

A 15-minute film, *All of One Company*, uses film, photographs, sound effects and personal testimony to give an insight into the Battle of Jutland, Battle of the Atlantic and the landings in the Falklands in 1982.

Many other testimonies and accounts have also been recorded, while a series of interviews with serving and veteran RN personnel from WW2 to the present day were interviewed on film by schoolchildren.

Most of the displays are accompanied by touch-screen interactive screens for the iPad/tablet generation.

The centrepiece of these hi-tech features is a huge display table – 'the interactive timeline' of Royal Navy ships from 1900 to today.

Touch the ships and you can move them about the virtual ocean, fire their guns, launch Swordfish from the deck of HMS Ark Royal.

Yes, you can fire a Polaris missile from a 1960s R-class ballistic submarine. No, you can't play Global Thermonuclear War...

Aside from these fun elements, the interactive timeline also features 20,000 words, 850 photographs, and 20 videos describing key actions and moments over the past 115 years. Using your fingers you can spin these around, move them across the display screens, enlarge and reduce their size ('pinch and zoom'). It's all rather like the Hollywood blockbuster *Minority Report*.

On test runs, children used the board to learn about the RN's rich recent history, say museum staff, while adults were content merely crashing

the ships into each other...

The Great War exhibition opened hand-in-hand with the new galleries will change as the four years of the centenary pass. It opens with the pre-war arms race and the dramatic opening six or so months – before it settled into a blockade which may have strangled Germany but did little to appease the British public's clamour for a 20th-Century Trafalgar.

Those opening months brought triumph (the destruction of Graf Spee's squadron at the Falklands) and a fair degree of tragedy. Few events shocked the public more than the German Navy shelling Scarborough and Hartlepool (resulting in a huge recruiting poster campaign) and the loss of three aged cruisers, the Hogue, Aboukir and Cressy to a single U-boat.

AB Frederick Mogg from Canonbury in London was lost in the Aboukir. His family were told they would receive a gratuity of £34 19s 7d – about £16,000 today.

And on a lighter note, the true naval buff in 1914 could own Toby jugs of the two leading admirals of the day ('Hellfire Jack' Jellicoe, who proved rather more cautious than his nickname suggests, and David Beatty, the latter's cap at a rakish angle, naturally...).

Whether it's historic artefacts or playing out modern-day battleships, curator Matthew Sheldon hopes the new galleries will do justice to the men and women they depict.

"We've done a lot of work with both veterans and serving personnel to tell the story of the Royal Navy of the last 100 or so years. Many of these stories are undiscovered, from ordinary men and women, dealing with great changes in technology, in society, in the world," he said.



● HMS Alliance, restored to her original glory – and now with a viewing platform under her bow and (left) the sword of Royal Naval Division officer Vere Harmsworth, killed on the Somme in 1916

● The 4in gun of HMS Lance which fired Britain's first rounds of WW1 while (below) a family study the chart in HMS Alliance's refurbished control room





Entrance to the galleries charting the run-up to and first months of the Great War

# ow present

"Through our state-of-the-art interactive displays and exhibitions, we hope it will bring our collections alive – and into the 21st Century – for everyone to discover."

For all the money and effort that's gone into the new galleries, research suggests that visitors will only spend about an hour looking around.

"People only acquire a maximum of seven new facts on a visit to a museum," explains Deborah Hodson, the museum's learning manager.

"The average is actually three..."

One way of ensuring a little more info sinks into our porous brains is repeat visits.

Tied in with the opening of the new galleries a new year-long pass for tourists is being introduced covering all the official Royal Naval museums in the Portsmouth area: HMS Victory, Warrior, Mary Rose, Action Stations and the new-look National Museum in the historic dockyard; the Royal Marines Museum at Eastney; and the RN Submarine Museum and Explosion across the harbour in Gosport – they are linked with the attractions in Portsmouth by water bus...

...which takes us neatly over the water to Haslar Creek.

For there sits HMS Alliance, jewel in the crown of the Royal Navy Submarine Museum, pristine on the outside and alive with sounds, voices and smells on the inside after her two-and-a-half-year 'refit'.

Before her restoration Alliance was, says guide Mike Havenhand, "getting to a state where she was embarrassing".

And now, £7m later – funded by a mix of public donations and lottery money – she is, says the former submariner, "superb. Money well spent."

Every inch of Alliance's hull has been restored, repaired

or replaced – and a jetty built beneath her so visitors to the museum can walk underneath her bow for the first time, and her conservators can work more easily on the boat.

And inside every nut, bolt, cog has been removed, cleaned or restored, then replaced.

The attack periscope – previously stored in its well – has been restored and raised; it's trained on shipping moving around in the Solent (just as any submariner would want it).

The museum has also added what they call 'soundscapes' – from banter in the messdecks to taking Alliance to periscope depth – have been created by a sound artist throughout the boat.

Some of the effects are fairly obvious, such as the regular pipes. But it's the little touches which make the difference. An officer complaining that "the admiral's cat has left a little something for us". And it's impossible not to walk past the snoring submariner without pulling back the curtain on his bunk. Yes, it is a sound effect...

Also when it comes to enhancing the Alliance experience, staff have scoured eBay and made use of the generosity of enthusiasts and former submariners to root out not just ephemera from the late '40s through to the '60s, but also fittings, dials and kit not present before the revamp.

They come to life – the engines hum, the dials move, lights on displays flash. A pot mess bubbles on the galley stove.

The idea is to imagine stepping aboard Alliance mid-patrol, as if the crew have momentarily vanished.

"It's not about how Alliance works, but how she feels, what she was like to be aboard," explains curator Bob Mealings who's overseen the boat's

restoration.

"The sound system is phenomenal – very subtle, very atmospheric. It's all part of making Alliance much more vivid."

"Everything you see has been cleaned, restored, repainted, plus there's a lot of new equipment. It has been hard – particularly working in a confined space, but the results are superb. It's actually worked much better than we ever imagined."

Among those privileged to look around the boat ahead of her re-opening former crewman CPO(ERA) Bill Handyside who served in Alliance from 1956-58 and hasn't been aboard her in more than 50 years.

"I think she's great – especially the sound effects, it really brings her back to life. They have got the spirit of Alliance right, right back to her early days. She's just the same as when I was serving in her," he said.

Also as part of the revamp, Hollywood actor and former *Lovejoy* star Ian McShane – who filmed an episode of his antiques comedy-drama at the museum 20 years ago – has added his voice to a new documentary film charting Alliance's career.

Before the boat's restoration the museum attracted around 45,000 visitors a year.

With the boat's new look plus the new 'access all areas' pass, submarine museum staff are hopeful of upwards of 80,000 people a year visiting.

Alliance, which serves as a living memorial to all British submariners on eternal patrol, will be formally rededicated at a ceremony on May 12 attended by Prince William, who's patron of the restoration appeal.

Visit [www.historicdockyard.co.uk](http://www.historicdockyard.co.uk) and [www.submarine-museum.co.uk](http://www.submarine-museum.co.uk) for prices.



*The Tabor Group offers exclusive weddings at a choice of six premier locations*

Quote 'Navy' to receive **10% OFF THE WEDDING COST**  
Valid until 31<sup>st</sup> May 2014

## THE TABOR GROUP

WEDDING VENUES OF DISTINCTION

With over 20 years' collective experience of hosting tailor-made weddings, you can be assured that your special day will be perfect in every way. The Tabor Group aims to provide you with a heartfelt welcome, delicious food and drink and memories that will last a lifetime.

[www.thetaborgroup.co.uk](http://www.thetaborgroup.co.uk)  
[www.lastminuteweddings.co.uk](http://www.lastminuteweddings.co.uk)

All The Tabor Group venues offer:

- Exclusive-use basis for your day
- Indoor and outdoor civil ceremonies
- Stunning settings for your photos
- Your own Wedding & Events Manager
- Luxurious en suite accommodation
- Stunning wedding-night bridal suite



**Parklands**  
ESSEX  
01799 543800  
[www.quendonpark.co.uk](http://www.quendonpark.co.uk)



**Fennes**  
ESSEX  
01376 324555  
[www.fennes.co.uk](http://www.fennes.co.uk)



**Warwick House**  
WARWICKSHIRE  
01926 815738  
[www.warwickhouse.co.uk](http://www.warwickhouse.co.uk)



**Woodhall Manor**  
SUFFOLK  
01394 411288  
[www.woodhallmanor.co.uk](http://www.woodhallmanor.co.uk)



**Southdowns Manor**  
WEST SUSSEX  
01730 763800  
[www.southdownsmanor.co.uk](http://www.southdownsmanor.co.uk)



**Vasilias**  
CYPRUS  
01376 559742  
[www.vasiliasweddings.co.uk](http://www.vasiliasweddings.co.uk)





**FUNDRAISER OF THE MONTH**

**RFA ARGUS**



● Personnel aboard RFA Argus show off their beards

CONGRATULATIONS to the (very hairy) crew of RFA Argus who undertook a beard-growing challenge. Not only did the team manage to raise the CO's eyebrows for their efforts, but also £330 for the Royal Navy and Royal Marines Charity.

**Cash paid for culture**

DEPLOYED personnel from across the Royal Navy and Royal Marines will benefit from a slice of £200,000 as part of the RNRMC's Operational Welfare Grant.

The grant, issued annually to COs and paid directly to Welfare Committees, is the charity's way of supporting personnel as they undertake operational duties across the globe.

The funds are used at the discretion of COs and usually pay for social events, recreation

equipment, team-building activities and families' days.

In a much-appreciated thank-you letter, regarding last year's Operational Welfare Grant, Capt Iain Lower, CO of HMS Dragon said: "At a time when my ship's company was in need of a morale boost your support enabled my team to make the most of a well-earned port visit in Italy – conducting adventurous training, making cultural visits to the Vatican and Rome, and visiting Pompeii."

**In the fast lane with tyre deal**

THE Royal Navy and Royal Marines Charity is moving into the fast lane, thanks to a collaboration with online tyre wholesaler TyreFactors.com.

If your car needs a new set of tyres ask your type fitter to purchase them through TyreFactors.com.

You'll receive the tyres at wholesale price then they'll be delivered direct to your tyre fitter or to your home address and TyreFactors will make a donation to the Royal Navy and Royal Marines Charity.

If you are interested in taking advantage of this offer (it's available all year), then buy online at [www.tyrefactors.com/referrnrmc](http://www.tyrefactors.com/referrnrmc) using referral code RNRMC1113 or call TyreFactors on 01896 487070.



● LPTs Luke Steele and Ian Robinson

Picture: Keith Woodland

**Roped in for challenge**

TWO members of the Physical Training Department at HMS Collingwood are taking on an epic climb to support the Royal Navy and Royal Marines Charity.

In a less-than-conventional interpretation of the Road to Twickenham Challenge which usually sees individuals cycle, run or swim, LPTs Luke Steele and Ian Robinson have decided to climb the distance from Collingwood to the home of English rugby.

Their 'road' will see them climb 15 metre ropes over 500 times during a two-week period, totalling 4.65 miles.

Ian said: "Even though we've just started, I think I've completely underestimated this challenge, I already have blisters on my hand!"

"Of course rope climbing forms part of our physical training course, but I haven't done it for six

years but I'm doing it for a good charity."

Luke's attitude to the challenge is simple as he quotes Bruce Lee "As you think, so shall you be."

Ian and Luke will receive support on their epic journey as other military personnel from Victory Squadron will row the remaining 75.35 miles over two common sports afternoons.

Each individual will be challenged to row one mile in the fastest time possible.

Executive Officer Cdr Andy Phenna was on hand to cheer on the guys as the challenge began.

He said: "As a supporter of Navy Rugby for many years it's great to see the PT Staff raising money for a good cause, especially as this fundraising challenge links to this year's Army v Navy Rugby match. I wish them all the best in completing their journey to Twickenham."

**Stars to line up at rugby contest**

THE Royal Navy & Royal Marines Charity will be one of the beneficiaries of a rugby veterans' tournament to be staged in Helensburgh, the home town for HMNB Clyde in Scotland.

A number of former Royal Navy 1st XV players will be lining up alongside some stellar names from the international rugby scene on Saturday, May 31, at the Charity Sporting Prints Rugby Legends Veterans 10s.

Helensburgh RFC is hosting the event – a local club that regularly features serving personnel from both the Navy and Marines each Saturday.

Among the former international players taking part in the tournament are stars Junior Paramore, Thinus Delpont, Henry Paul, Sean Long, Colin Charvis, Leigh Davies, Rob Henderson, Duncan Bell, Jason White, Jon Petrie and Gordon Bulloch.

One of the event organisers, CPO (Coxn) Chris "Taff" Thomas, who played many times for the full Royal Navy rugby team and currently works at HMNB Clyde, said: "We are delighted to be bringing so many top-class former internationals to the event."

"It really will be a privilege to play alongside these guys."

"Veterans' rugby is a growing area of the sport and already local boys here have played in events in Dubai and at the Melrose Veterans' event which preceded the Melrose Sevens."

"We hope to raise a significant amount of money for the Royal Navy & Royal Marines Charity and would urge as many people along as possible to take part in what should be a great day."

Rugby for Heroes, Maggie's, Wooden Spoon and Velindre Cancer Research are the other charities involved in the event.

Tickets for the event are available on the day or can be pre-ordered by contacting Coxn Chris Thomas on Faslane 93255-5997 or by visiting [www.charitysportingprints.com](http://www.charitysportingprints.com)

**A PIECE OF LIVING HISTORY**  
CELEBRATING 350 YEARS

**BEATING RETREAT 2014**

FEATURING  
**THE MASED BANDS OF HER MAJESTY'S ROYAL MARINES**  
AND SPECIAL GUESTS  
**THE BANDS OF THE ROYAL NETHERLANDS AND US MARINE CORPS**

**3-4 JUNE 2014**  
HORSE GUARDS PARADE

TICKETS FROM £12  
CALL: 0844 847 2504  
[WWW.TICKETMASTER.CO.UK/BEATINGRETREAT350](http://WWW.TICKETMASTER.CO.UK/BEATINGRETREAT350)

Promoted by RNRMC Enterprises Limited. Registered office: Building 29, HMS EXCELLENT, Whale Island, Portsmouth, Hampshire, PO2 8ER. RNRMC Enterprises Limited gifts all of its profits to The Royal Navy and Royal Marines Charity (No.1117794).

**£3m windfall for charities**

MORE than £3m has been split between 17 Naval Service charities in the latest round of grant-making by the Royal Navy and Royal Marines Charity.

The scope of charitable organisations and projects the charity has elected in this round of major benevolence grants are truly inspiring.

They cover a wide range of needs from health and well-being for veterans to training for Service leavers and support for children with disabilities.

In the south of England, the children of Portsmouth and Gosport-based naval families will benefit from a £50,000 grant to KIDS, whose work helps disabled children and young people to gain independence, social skills and self-confidence.

To the north of the country meanwhile, Scottish veterans' charity Erskine received £50,000, to help with the care of 31 Royal Navy and Royal Marine veterans at the

Erskine Home in Bishopton, Renfrewshire.

The needs of veterans were also represented by two £30,000 grants, allocated to Veterans Aid and the Not Forgotten Association, both of which support injured Servicemen and women.

The UK-wide Regular Forces Employment Association also received a grant of £78,150 to help it re-train Service leavers.

Anne Carr, Head of Grants at the RNRMC, says: "We're always thinking ahead to meet the needs of naval families, as they continue to change throughout each stage of their lives."

"Therefore, we take care to make sure that we allocate money to causes which will have the biggest impact on their health and well-being."

The largest beneficiaries in the latest round of grants include the Royal Naval Benevolent Trust (RNBT), whose primary beneficiaries

are naval ratings (and their RM equivalent) and their families. Since November last year, the RNBT has received more than £1.5m from the RNRMC.

A total of £720,000 was granted to the Royal Navy and Royal Marines Children's Fund for their ongoing and committed work with Service children.

In total, £3,063,250 was granted by the RNRMC to the following charities: Blind Veterans UK, Erskine, Royal Star & Garter Homes, Queen Alexandra Hospital Home, SSAFA Forces Help, Recovery Pathway, Regular Forces Employment Association, Veterans Aid, Not Forgotten Association, Poppy Scotland, Poppy Factory, STOLL (Sir Oswald Stoll Foundation), KIDS, Plymouth Drake Foundation, Sailors' Children's Society, the Royal Naval Benevolent Trust and the Royal Navy and Royal Marines Children's Fund.

**EVENTS**



**Sporting showdown**

The Army v Navy rugby match takes place at Twickenham on May 3.

Will the Navy triumph over last year's Babcock Trophy winners? Please Tweet your pics to @RNRMC.



**HMS Collingwood Open Day**

The fun-filled day, featuring the annual Field Gun Competition, is held in aid of The Royal Navy and Royal Marines Charity. Gates open at 9.30am. For ticket details visit: [www.royalnavy.mod.uk/collingwood-opensday](http://www.royalnavy.mod.uk/collingwood-opensday)

**FUNDRAISE | DONATE | SIGN-UP TO PAYROLL GIVING**

CONTACT US: [FUNDRAISING@RNRMC.ORG.UK](mailto:FUNDRAISING@RNRMC.ORG.UK) / 023 9254 8289 | FOR MORE INFORMATION VISIT: [RNRMC.ORG.UK](http://RNRMC.ORG.UK) | FIND US ON FACEBOOK AND TWITTER





● ET(WE) Chris Bowns

## Helping pilgrims' progress

ET(WESM) Chris Bowns made a big splash when he swam 2.5km at HMS Collingwood – raising awareness and support for HCPT The Pilgrimage Trust.

Chris, originally from Ely where parents Ruth and Steven still live, decided to take the plunge for the charity after hearing about their good deeds from MAA Eileen Harvey.

The challenge was no easy feat for Chris, who only began learning to swim two years ago after finding out it was a requirement to join the Royal Navy.

His pledge to swim was made more of a challenge after joining the Royal Navy 11 months ago when after injury he was medically downgraded.

His preparations for the event saw him take up swimming a few weeks prior to enable him to swim the 76 lengths of the 33 metre pool at the Sports and Recreational Centre at the Fareham base.

He said: "I'd been looking for a charity to get involved with and HCPT fit the bill perfectly. One of my career highlights since joining the Navy was visiting Lourdes, South of France on the annual International Military Pilgrimage during my Phase 1 Training at HMS Raleigh and I saw where the respite breaks take place."

The challenge took Chris one hour and 15 minutes to complete and so far he's raised £190 for the charity.



● The Rev Ernie Grimshaw leads the cold water training for the Tough Mudders team off Stokes Bay

Pictures: LA(Phot) Guy Pool

# Some mudders do 'ave 'em

A TEAM of 12 personnel from across HMS Sultan visited Stokes Bay, Gosport, to participate in some specialist training.

The personnel involved could be seen running across the shingle beach, climbing up grass mounds, racing each other as human wheelbarrows and jumping into the sea, all in order to prepare themselves for the Tough Mudder challenge.

The Tough Mudder is a 10-12-mile obstacle course consisting of military-style challenges which are designed to test participants both physically and mentally. Since its conception in the USA in 2010 over one million people have taken part across three continents.

Chaplaincy worker Susie Templeton, who organised the event alongside POAET Paul

Barlow, said: "Our team is made up of individuals from all over the establishment, including The Haven (part of the chaplaincy), sickbay, the SPVA, and we have a number of personnel who are from the RAF and a few civilians like myself and fellow chaplaincy support worker Bobby Tait.

"We chose to show our support for Combat Stress as the charity supports veterans to deal with a lot of internal hidden hurts and mental illness and the Tough Mudder is a public display of a physically and mentally demanding challenge which demands a lot of mental strength to conquer."

LPT Kelly Gooch, who has led the group's physical preparations, said: "We started training for Tough Mudder just after Christmas and I have tried

to tailor our training towards the course through weekly circuit training and we have also done a lot of work on overall body strength. It's a massive event and you do need to have some form of fitness."

Chaplain the Rev Ernie Grimshaw, who is in his last draft in the Royal Navy, said: "In terms of fitness I can't bring much to the team but I am certainly prepared to make myself the fool in order to bring in some humour and egg the others on."

The average completion rate for participants who take on the Tough Mudder is 78 per cent.

They were taking part in Tough Mudder at the end of April. To make a donation please visit: [www.justgiving.com/HMS-Sultan-Haven](http://www.justgiving.com/HMS-Sultan-Haven)



● POAET Paul Barlow leads teammates over the grass mounds at Stokes Bay



● Members of the Logistics Department with their cakes

## Echo takes the cake

THE logistics department of HMS Echo made time for tea in aid of St. Margaret's Hospice, the ship's chosen charity.

St Margaret's Hospice is a Taunton-based charity committed to providing specialist palliative care, advice, support and respite to patients and their families for those who have a terminal or life-shortening illness.

The catering staff prepared a selection of cakes ranging from raspberry with vanilla cream to chocolate topped with butter cream, popping candy and marshmallows.

Tea and coffee were served by Lt Isha Harvey and the rest of

the logistics department.

Lt Harvey said: "The chefs showcased their talents, the sailors enjoyed some delicious treats, and most importantly, money was raised for St. Margaret's Hospice.

"It is a charity with which I have a strong personal connection having had friends benefit from the excellent care at the Yeovil Hospice."

All of the ship's company had the opportunity to buy a cake. The money raised was added to the total for the deployment which has reached £1,122.70.

The ship's company are aiming to raise over £1,500 before they return to the UK later this year.

## Marching for Cody

A ROYAL Navy careers officer was joined by family and friends for a charity walk in memory of their baby son.

Lt David Tinsley and his wife Louise walked just over 35 miles from Doncaster to Leeds to raise cash for the Children's Heart Surgery Fund.

The couple's son Cody died aged 15 weeks of cardiomyopathy (heart disease) and was treated at Leeds General Infirmary and Great Ormond Street Children's Hospital.

Lt Tinsley said: "It was a challenging day for everyone, but it was worth it, and we thought of Cody every step of the way.

"We are so grateful for the response from our friends and colleagues and it has helped us give something back in memory of our son.

"The Children's Heart Surgery Fund will use the money to enhance support for babies, children and teenagers with all manner of heart defects and we look forward to supporting them further in the future."

So far the march has raised more than £4,000. Anyone wishing to donate can visit [www.justgiving.com/codysmarch](http://www.justgiving.com/codysmarch).



● Personnel from BURNU with Allen Parton and other supporters

## Dogs have their day

MEMBERS of Birmingham University Royal Naval Unit teamed up with the charity Hounds for Heroes at Crufts, the international dog show at the Birmingham NEC, near BURNU Headquarters.

Six Midshipmen from Birmingham URNU were present at Crufts alongside Hounds for Heroes, who had other support from local police officers, the Chelsea pensioners and the RAF Police dog demonstration team.

Throughout the day, the midshipmen engaged with members of the public, explaining work the charity does to support injured men and women across the Armed Forces and the

emergency services; as well as providing a constant uniformed presence at the largest dog show in the world.

Mid Alex Harris, a first year student from University of Birmingham said: "Getting involved with Hounds for Heroes proved to be a fun and rewarding experience for the midshipmen from BURNU."

Hounds for Heroes is a British charity set up by former Royal Navy CPO Allen Parton, who was injured in the first Gulf War. The charity was founded in 2009 and launched in February 2010 to help train, provide and support service dogs to injured Service personnel.

## Charity snippets

■ A TEAM of four sailors from HMS Collingwood are taking on the world's biggest assault course in aid of The Royal Naval Benevolent Trust (RNBT).

The 'Rat Race Dirty Weekend' will see them overcome the 'Full Mucker' course consisting of 200 obstacles over 20 miles.

The event will see the quartet travel to Peterborough in May and complete in activities whilst wading through waist high mud, jumping from high platforms on construction sites and swimming across reservoirs.

PO Matthew Sommerville and three of his colleagues from the Above Water Tactical Department have signed up for the event this month. They hope to raise £1,000 for the RNBT.

Sailors from the Fareham base raised £120 for the charity by donating £1 for every pancake they ate to mark Shrove Tuesday.

■ ROYAL Navy officers on the Intermediate Command and Staff Course (Maritime) at the UK Defence Academy held a charity horse-racing night and raised £350 for the Rainbow Trust.

The 40 students on the two-month course donned a variety of fancy dress for the event at the Shrivenham-based Academy.

The Rainbow trust provides Family Support Workers to give practical support to families with terminally-ill children.

■ THE Officers' Association is considering changes to its employment and benevolence offering.

Potential changes include establishing more offices across England and Wales as well as providing greater support for officers seeking employment outside of the Armed Services. Other developments may include broadening its focus from solely job-seeking advice to providing greater practical support.

■ OFFICER Cadet Steffi Stone took the honours at the Great London URNU Bake-off – the highlight of the unit's fundraising calendar.

Her HMS Puncher inscribed lifebuoy-inspired carrot cake fended off the competition at the event which raises funds for Seafarers UK. The final total raised was £214.

■ A COLLECTION in the WO's and Senior Rates' Mess at HMS Drake raised £110.40 for HCPT 507 Joint Services Group, which takes Service, ex-Service and dependants on an international military pilgrimage to Lourdes in France.

■ THREE charities were rewarded for their work in the field of mental health. SSAFA, RBL and Combat Stress were among the winners at the Mental Health First Aid England Awards at the House of Lords.

■ NATIONAL military charity SSAFA was the chosen beneficiary of this year's Grand Military Gold Cup Day at Sandown Park. The day's feature race, the Grand Military Gold Cup, dates back to 1841 and showcased some of the country's best amateur jockeys.

■ LS(HM) Ben Wansborough is taking part in a 190-mile charity bike ride from Plymouth to Portsmouth in June in aid of the Royal Navy and Royal Marines Children's Fund.

The sailor is undertaking the event after his four-week-old daughter was diagnosed with a bleed on the brain.

"Without the help of the RNRMCF, my partner and I would not have been able to stay in Bristol to support our daughter," he said.

To sponsor Ben visit [www.justgiving.com/plymouth2portsmouth](http://www.justgiving.com/plymouth2portsmouth)





# EQUATOR



# NIGERIA



# SÃO TOMÉ



# ANGOLA

Pictures: LA Phot Caroline Davies, HMS Portland

**A**ND you thought Middle Earth was a Tolkienian creation.

Nope. It's actually 385 miles south of Accra in Ghana, 635 miles west of Libreville in Gabon and about 1,150 miles northeast of the tiny volcanic outcrop that is Ascension Island.

Yep, 0° Latitude, 0° Longitude is the middle of nowhere.

But wherever you're passing over the Equator in Her Majesty's Ships, you have to pay your respects at the court of King Neptune.

More than half the ship's company of HMS Portland – 120 souls in all – had yet to sail across the invisible divide between the two hemispheres.

And so it was that they went through the age-old mariners' ritual – performed in time of war as well as peace – which ended with the bears of King Neptune's court dunking them in a pool.

All perfectly normal...

The Equator might be the half-way point between the two Poles, but crossing it came in the early stages of the Devonport-based frigate's seven-month South Atlantic patrol.

That patrol has, as the name suggests, traditionally focused on the eponymous ocean and half a dozen

British territories therein.

Increasingly, however, there's a very strong African element to the deployment – less flag flying (though that's still important), more working with the navies and maritime agencies in the region to tackle crime off the African coast, from drug trafficking around the Cape Verde Islands to piracy in the Gulf of Guinea where there are now around 100 attacks a year.

At pretty much every port of call as Portland edged her way southwards, the frigate has been training with local forces – normally on a small scale, occasionally larger.

Ten ships from ten nations from the Atlantic rim, half of them African, joined Portland for the fourth run out of Saharan Express, the largest naval exercise of its type in the region, billed by Rear Admiral Cheikh Bara Cissokho, the head of the Senegalese Navy, as seven days of "brotherhood, friendship and building the essential confidence to counter challenges we collectively face".

The emphasis in this year's Saharan Express – played out between the coasts of Cape Verde and Senegal – was tackling the illegal movement of

arms in support of terrorist and pirate groups, as well as dealing with the rise of illegal fishing.

The Atlantic off the West African coast was one of the richest fishing grounds in the Seven Seas – home to shoals of mackerel, shrimp, sardines among other marine life. Such stocks have been denuded terribly by illegal fishing – mostly, though not exclusively – by non-African vessels.

**A**mong the African nations committed to secure seas, São Tomé and Príncipe.

Not heard of the republic? Perhaps not too surprising. The two islands in the Gulf of Guinea form Africa's second smallest state (the smallest distinction belongs to the Seychelles).

If you've not heard of São Tomé and Príncipe – and we're taking a stab that most of our readers probably haven't – the islands are about 87 miles apart and 150 miles off the northwestern coast of Gabon. Together, they number 187,356 inhabitants (God bless Wikipedia...).

If the islands have featured in the pages of Navy News before, then it'll be some time in 1985 – the white-hulled survey ship HMS Herald visited.

Before that you have to rewind a

further 96 years – 1889, when the Eiffel Tower was opened – for the only other time the White Ensign has been seen within sight of either island.

So there was understandably a bit of interest in Portland's appearance off São Tomé for a two-day visit, both from islanders and from the ship's company, eager to visit somewhere few matelots have been before.

The ship hosted the prime minister Dr Gabriel Costa and a number of his ministers, while sailors provided training in navigation, mechanical engineering, fire-fighting and boarding operations to members of the São Tomé and Príncipe Armed Forces.

A large number of sailors seized the opportunity to explore São Tomé on foot, bicycle or bus. Highlights included a visit to the St Nicoalo Waterfall and the Corallo chocolate factory; one of the island's major exports is cocoa.

"This was a great opportunity to explore a beautiful Island that very few people have visited," said AB(WS) Holly Tobbell.

"Visits like this are one of the reasons I joined the Royal Navy."

**S**ome 750 miles southeast of São Tomé is the Angolan capital Luanda,

home to 15 times more people than the two-island republic – and the next port of call for the Devonport frigate where (you guessed it) there was a mix of championing Blighty and combined training with the host nation's navy.

The ship's company paid their respects to modern Angola's founding father and national poet Agostinho Neto who died in 1979 after four years as the country's first president.

And the sailors were also invited to delve into the African nation's military history courtesy of a museum located in the fortress of São Miguel, a 16th-Century bastion overlooking the city. It charts the country's history through war and peace from the days of Portuguese rule through to independence.

The fortification also provided the impressive setting for a 'thank-you evening' hosted by the Angolan military for the support and training the Royal Navy personnel had provided during the visit.

Portland sailors were treated to an evening of traditional Angolan food, native dancers and a live band.





# AFRICAN RHYTHM



## SOUTH AFRICA



## NAMIBIA

"I really enjoyed the visit to Luanda and the opportunity to train with another Navy," said ET(WE) James Bowen.

"The reception was also great fun and was set in the fantastic setting of a 16th-Century fort."

The next country along the coast from Angola, heading south, is Namibia. And, well, it would have been rude not to visit...

Walvis Bay is Namibia's principal port – indeed it's one of few havens for sailors on an otherwise largely hostile stretch of coast.

Now we know you'll find this hard to believe but... once in the port, the ship hosted a reception and capability demonstration, and conducted joint training with local forces.

But forging bonds in foreign parts invariably extends beyond VIPs and the military.

Take Walvis Bay Kids Haven, a safe home for 30 abused and vulnerable children.

It was set up five years ago, during which time it's provided a sanctuary for 427 children, ranging from newborn babies through to 18 year olds.

What those youngsters didn't have, however, was a playground, until the British High Commission in the Namibian capital Windhoek donated Namibian \$10,000 (about £570) to build a playground – which had mostly been finished by the time Portland arrived.

Enter 20 members of the ship's company who volunteered to help out, spending a day painting the playground and entertaining the children, before it was formally handed over to the children's home by the British High Commissioner Marianne Young and Portland's XO Lt Cdr Rob Brann.

"The children were great fun to be with throughout the day and we could all see how much enjoyment they will get from this playground," said ET(WE) Jane Anderson.

Thanking the sailors for their efforts in the broiling sun (34°C), Mrs Young told them: "Today you have touched the hearts of many children and made a difference to the future of these children here in Walvis Bay.

The heat must have played a part in the sporting arena, for the Brits went down 40-13 on the netball court to a team from the Namibian Navy.

Eight hundred miles further south brings us to the southwestern tip of the 'rainbow nation' – and the mid-way point in Portland's deployment: two weeks' leave for many of the ship's company (who flew families out); two weeks' maintenance for the frigate herself...

...but only after some military training with the SAS.

No not the Hereford Walking Club. SAS (South African Ship) Charlotte Maxeke is one of three German-built diesel boats in the Republic's navy.

And Portland is purpose-built for hunting down such craft.

So it would be rude not to give it a go. As this was a 'home game' for the South African submariners, they knew every inch of the waters off the Cape – not least the thermal layers, which put Portland's sonars and sonar operators to the test. The foe, says the frigate's CO Cdr Sarah West, was "very, very quiet".

And had her frigate relied on the Mark 1 eyeball to spy the submarine... well, she'd have been stumped, because the choppy waters meant there would have been little, if any, chance of sighting Charlotte Maxeke's periscope.

War games done, Portland made for Cape Town's historic Victoria and Albert waterfront.

Once alongside, Portland joined in the government's GREAT Britain campaign – which the RN has been promoting around the globe for the past couple of years, celebrating British innovation, technology, business, sport, knowledge and creativity.

As elsewhere on her African odyssey, the ship treated local dignitaries to demonstrations and a reception, while 150 Cape Town schoolchildren were given an insight into life in the Senior Service.

The youngsters were also able to enjoy 5-a-side football on a specially-constructed pitch next to the ship, experience a simulator of the Bloodhound Supersonic Car (which is aiming to break the land speed record at Hakskeen Pan in the north-western corner of South Africa), tour Portland and enjoy a pirate-themed party hosted by the sailors.

"The children all really enjoyed their time on Portland," said ET(WE) Ben Venables, one of the party hosts.

"They were impressed by the size of the ship and had great fun at the party.

I was part of the 'soak a sailor stance' and they seemed to get real delight throwing buckets of water over me!"

Among the visitors was a talented group of musicians from the group Izivunguvungu (which should make a good score at Scrabble...). The group turned the frigate's forecastle into an impromptu stage and performed two sets – which drew an audience not just from the ship's company but also many people wandering around the waterfront.

A quick 60-mile sail around the Cape of Good Hope and into False Bay for mid-deployment maintenance in Simon's Town, home of the South African Navy.

The frigate's Lynx flew off to Ysterplaat air base for some training with its SAAF Super Lynx counterparts – as is the wont of Fleet Air Arm flights visiting this part of the world.

And many of the sailors soaked up the Cape sun – although the Austral autumn was well under way, temperatures were in the high 20s/low 30s Celsius.

Enjoy them while they last, folks, because it's not redders on the other side of the South Atlantic. More roughers...



CLASSIC JACK



JACKPOT!



Each month Pusser's Rum are offering to courier a bottle of their finest tipple to the writer of our top letter. This month's winner is WG Ellis

Sand and water to wash greasy plates

RE: FRANK Clayforth's Memories of HMS Osiris in March's Navy News. After four-and-a-half years as a Tel(F) I was called back to general service and given an overseas draft. I was drafted to Fayid to help in the closing down of the W/T station and then going to Nicosia (HMS Aphrodite) to open a new one. I was in Egypt about a month, thankfully, but what I shall never forget was the 'Sweetwater Canal' (what a misnomer) and having to wash greasy plates with sand and cold water; also swapping watches with a Wren 'Sparker' so she could take part in the special BS parade being put on when Lord Louis

Mountbatten paid a visit. If my memory is correct, it would be October 1954 when Nicosia W/T opened up and it was April Fool's Day 1955 when I went on the Forenoon watch and found an unexploded bomb under the TCS radio equipment. The bomb was made with a whisky bottle, filled with petrol and three sticks of dynamite taped to it. The EOKA had thrown it through the window of the Nissen hut, which was the W/T and Crypto Office. If anyone remembers me and wishes to get in touch call 01406 381144. WG (Mick) Ellis Spalding, Lincs

Wrong site for a party

ADMIRAL Lord Nelson is, by now, probably rather used to looking down from his column to see which bands have taken over Trafalgar Square. No longer just a focus for celebration, protest sometimes, it's a music venue promoted by City Hall.

The Merchant Navy Memorial in Trinity Square Gardens, by Tower Hill tube station, is a memorial to tens of thousands of merchant seamen who have no grave but the sea.

Yet, in 2011, Tower Hamlets Council gave party licences for Christmas 'functions' in the gardens until objections made them see sense.

It's obscene that anyone should think a war memorial suitable for parking one's glass.

Now, Wren's Old Royal Naval College, Greenwich, centrepiece of Maritime Greenwich and a World Heritage Site, is to be an outdoor concert venue in August.

What state the place will be in after four nights and 16,000 people is hard to imagine, though the mess that Hyde Park is after big events gives a clue.

It is often said the British are sea blind.

Our civic leaders are deaf, too, it seems, to ancient mariners, dead and alive.

Those involved with these plans probably don't even see these memorials and heritage sites as revered parts of our national story but as open spaces ideal for loud noise, alcohol and partying, what others might call desecration.

Lester May (Lt Cdr Rtd) London

End to mess over rum tot

THERE seems to be confusion over what constituted a tot of rum by people who should know better.

Here goes:

One tot of rum equals 1/8th of a pint. Given neat to senior rates.

One tot of grog equals one tot of rum, 1/8th of a pint, and two tots of water, which equals 3/8ths of a pint.

The tot given to junior rates - one of grog, equals 3/8th of a pint.

G Rutherford Derby

Blagged posting on the original Astute

IT WAS interesting to read the article about Ron Raymond's visit aboard the new HMS Astute in the March Navy News, and your comment that he "must be one of the last-known sailors to have served in the original HMS Astute."

Well, here's another, a Canadian off in distant Ontario, Canada. I'm now 89, and an ex-RCN Reserve.

I was an A/S specialist, and having taken the course, in 1961 I thought it a good idea to find out how my "targets" operated.

At the time the RN maintained

the 6th Squadron at Halifax, two or three 'A' boats at a time.

To the surprise of my local support staff, when I said I wanted a training period in one of those boats, they promptly replied "There's no way! You're not a submariner, and they're RN, not RCN."

Since I worked for the local telephone company, I called the 6th Sqn shore office and asked directly.

A cheerful soul said: "Sure, glad to have someone take an interest in what we do. In peacetime there's a spare berth,

so come along!"

As a pretty senior Lieutenant by then, I told our training office: "Just put in the application." They were rather stunned when it came back "Approved."

I had a great three weeks in Astute, under Lt Cdr Ringrose-Vose, doing extended exercises with our new destroyers, down to Bermuda and back.

Learned a tremendous amount my courses hadn't taught me, and all on board were most helpful in teaching a newcomer.

Even took Sunday Divisions as Parade Commander for a

final inspection by FOSM on a Canadian inspection tour, and given a stiff rum "up spirits" in the chief's mess on board on my departure I even got 1/2 submarine extra pay (as not yet qualified!).

Even after 53 years it was a great boat, well and smoothly run, quite different from the operation of surface ships I'd been used to.

I guess the new Astute would be as different again!

Fraser McKee (Cdr, RCN (Reserve, rtd) Ontario, Canada

Warm welcome from islanders

I THOUGHT you may be interested in the last visit my wife and I made to the South Atlantic.

Our first stop was Port Howard in the West Falklands, where we visited the stone memorial to the night HMS Alacrity sank the Argentine supply ship Isla De Los Estados.

It is only a short climb from the settlement and well worth a day visit.

We also visited the grave of Capt Gavin Hamilton MC, which overlooks a river. His family will be pleased that the cemetery is kept in beautiful condition. His military details and some photographs are on view at the museum at Port Howard.

We then stayed with Andi and Mathew at Kings Valley Farm, San Carlos. The farm is only two minutes from the cemetery but a rugged drive to the Ajax field hospital and the Ardent and Antelope memorial on Campito Mountain, which also has plaques from all the Type 21s. Both well worth a visit.

Mathew only purchased the farm this year and his claim to fame is that he was, at three months old, the youngest of the 114 residents interned in Goose Green for a month by the Argentine forces in 1982.

Boarding a Russian ice-breaker, we sailed to South



● Capt Hamilton's grave. The SAS officer died on June 10 1982 at Port Howard



● Clive Morris at the memorial at Port Howard

Georgia. We visited several places, including Stromness and Grytviken. In the cemetery we found the grave of Felix Arturo, the only Argentinean to die in the taking of the sub Santa Fe.

We look forward to returning

to the Falklands where we have found the people so friendly and grateful for their liberation in 1982.

Clive Morris (ex-HMS Alacrity) Michigan, USA

Musical surprise

ON reading the letter about King Neptune's present in the March edition of Navy News, I was very surprised that our organ had made its way so far north.

It was last seen floating on the tide in a fading light evening in March 1940 as we were leaving Greenock on our journey to Norway via Scapa.

It was launched over the stern. Very few of us knew anything about this until after we arrived in Scapa. Suddenly, on the Sunday morning we got the order: "Clear lower deck, everyone to search for a missing organ."

We eventually had the morning service but it seemed very strange, and some felt very sad, without the pianist, paymaster Lt Stanning and his beloved organ being there.

Little did we know that there wouldn't be many more Sundays left to hear them playing for us.

Ralph Briggins (Ex-signalman, HMS Hardy) West Sussex

Revenge of sister ships

I WAS very interested to read the concise but very informative article concerning the cruiser HMS Monmouth in the April edition of Navy News.

However to come to the defence of the Monmouth class of cruisers it is worthy of note that two other vessels of the class (Kent and Cornwall) avenged the loss of their sister by fighting with distinction at the later Battle of the Falkland Islands (1914).

HMS Kent sank the German light cruiser Nürnberg on December 8 1914 and HMS Cornwall, along with Glasgow, sank the Leipzig on the same day.

Cornwall went on to assist with the blockade of the German cruiser Königsberg off East Africa. Another sister, HMS Berwick, captured the German merchant ship Spreewald in the South Atlantic on September 10 1914.

Ian Richardson Durham



LETTERS to the editor should always be accompanied by the correspondent's name and address, not necessarily for publication. E-mail correspondents are also requested to provide this information. Letters cannot be submitted over the telephone.

If you submit a photograph which you did not take yourself, please make sure that you have the permission for us to publish it. Given the volume of letters, we cannot publish all of your correspondence in Navy News, nor can we reply to every one. We do, however, publish many on our website, www.navynews.co.uk, accompanied by images. We look particularly for correspondence which stimulates debate, makes us laugh or raises important issues. The editor reserves the right to edit your submissions.

ROYAL NAVY NAVY NEWS

Mail Point 1-4, Navy Command, Leach Building, HMS Excellent, Portsmouth PO2 8BY

May 2014 No. 718: 60th year

Editor: Mike Gray 023 9262 5257 or Mil: 93832 5257

Editorial News editor: Richard Hargreaves 023 9262 5255 Production Editor: Lorraine Proudlock 023 9262 5282 edit@navynews.co.uk General enquiries and archives: 023 9262 3553/5847 Business Business manager: Lisa Taw: 023 9272 0494 Subscriptions: 023 9272 6284 subscriptions@navynews.co.uk Accounts: 023 9272 0686 Advertising: 023 9272 5062 advertising@navynews.co.uk Fax: 023 9273 4484



## Epic yomp in Falklands

WITH the Union Flag fluttering in the strong Falklands wind, Royal Marines from HMS Protector approach Stanley – just like their forebears in 45 Commando more than 30 years ago.

A team of five green berets from the Navy's ice patrol ship yomped the 120 kilometres (75 miles) across East Falkland – carrying full kit and following the exact route that the Arbroath Royal Marines marched and fought in 1982.

The team from Protector – which is on an 18-month deployment carrying out scientific research and updating maritime charts in the South Atlantic and around Antarctica – were dropped off at San Carlos, where British forces came ashore in May 1982, with the goal of reaching Stanley and liberating the islands.

It took 45 Commando more than three weeks to cross East Falkland 32 years ago with the threat posed by Argentine forces compounded by the onset of the Austral winter – they fought their way to Stanley in May and June, equivalent to November and December north of the Equator.

It was still late summer when the Protector commandos set off and four days later the team were welcomed into Stanley.

“One of the highlights of the yomp was seeing a Globe and Laurel flag outside a Royal Marines Association veteran's house in Stanley as we passed,” said Mne Rob Davis.

“As we got closer towards the centre we came across a house with all its windows wide open and the secretary of the Falkland Islands RMA playing *Life on the Ocean Wave* at full blast for all to hear.

“This was certainly a moment which made us tremendously proud of our week's endeavours and to be able to say we had retraced the 45 Commando Falklands yomp as accurately as possible in the Royal Marines' 350th anniversary year.”

Picture: LA(Phot) Vicki Benwell



Royal Marines 350  
1664 - 2014  
Timeless Distinction

## Life on camera

TELEVISION production company Twofour Broadcast has completed six weeks of intensive filming at the Commando Training Centre Royal Marines near Lympstone, Devon.

The company, that also made the award-winning *Educating Yorkshire* and *Harry's South Pole Heroes*, wanted to make a groundbreaking series about military training and chose to follow the Royal Marines.

After a lengthy period of research, Twofour began filming at the Lympstone training base in early January, using a mixture of wall-mounted cameras and traditional hand-held technology.

Although the six weeks of fixed-rig camera filming is now complete, hand-held camera crews will periodically follow the recruits until the summer.

The editorial process is expected to be complete by August with the series likely to air in the autumn.

A website will also accompany the series.

# Sunnier days for challenge

AFTER a brief period of rest and recovery – the second phase of the Royal Marines 1664 Challenge has got under way.

Fresh from their ski down the length of Norway the men are facing the steely grey of the North Sea as they race southwards across the Bay of Biscay to Cadiz, in Spain on board Endeavour, pictured.

The Royal Marines 1664 Challenge is one of the ways in which the Corps is celebrating its 350th anniversary this year.

It is made up of five phases – ski, sail, cycle, canoe and run – with the transition from ski to sail having just taken place in the southern Norwegian city of Stavanger.

The green berets were expected to arrive some 1,664 nautical miles south in Cadiz at the end of April where they will start pedalling 1,664 kms back towards the UK.

By the time the Challenge arrives in London, in July, more



than 4,200 commandos will have participated hoping to raise around £500,000 for the Royal Marines Charitable Trust Fund, the charity of the Royal Marines. Cpl Tom Rounding, from Hull, representing 30 Commando, based in Plymouth, said: “The ski phase of the Challenge was about

performing at peak physical fitness across inhospitable terrain in unpredictable weather. But in many ways it was familiar as we train in Norway in winter.”

Representing 45 Commando, in Arbroath, Scotland, is the youngest man in the core group of six, Mne Tom Barker.

The 19-year-old, from Carlisle, added: “After more than two months in Norway we have come to know the country, and its people, very well so it is sad to be leaving. But the ski phase taught us many important lessons as we had to deal with every eventuality, as a small team, often miles from civilisation. This was all relevant as we are going to be in a yacht, far from shore, and teamwork will be vital.”

Follow the challenge at [www.1664challenge.co.uk](http://www.1664challenge.co.uk) while regular updates are being posted at [www.facebook.com/rm1664challenge](http://www.facebook.com/rm1664challenge) as well as their Twitter feed @RM1664challenge.

## Iconic images on new stamps

BY SEA, by land and now by post as the Royal Marines' 350th birthday is celebrated with a collector's edition stamp sheet.

Available from the Royal Mail is a commemorative sheet of ten stamps charting key moments and actions involving the Corps since it was formed in the 17th Century.

The sheet, entitled ‘By sea, by land’, has been

endorsed by the Duke of Edinburgh as Captain General of the Royal Marines, who has provided a short quotation extolling the virtues of the Corps.

Ten first-class Union Jack stamps sit alongside iconic images from the Corps' illustrious history.

The Royal Marines' sheet costs £14.95 and is available online at [www.royalmail.com/royalmarines](http://www.royalmail.com/royalmarines) and at selected Post Offices.



A Naval Charity providing, personal help and advice for all serving and former members of the Royal Navy, Royal Marines, their Reserves and Families on;

### Personal Finance

Including - resettlement finances, pensions and commutation

### Civilian Employment

[www.whiteensign.co.uk](http://www.whiteensign.co.uk)

020 7407 8658 ~ [office@whiteensign.co.uk](mailto:office@whiteensign.co.uk)

HMS BELFAST, Tooley Street, LONDON, SE1 2JH

Follow the Royal Marines during their anniversary year at [www.Royalnavy.mod.uk/RM350](http://www.Royalnavy.mod.uk/RM350)





# 'Entente fo

FOUR years on from the signing of the Lancaster House Agreements, the heads of the Royal Navy and the Marine Nationale – First Sea Lord Admiral Sir George Zambellas and *Chef d'état-major de la Marine* Amiral Bernard Rogel respectively – answered questions posed on behalf of *Navy News* and our French colleagues at *Cols Bleus* as to what effect the treaties have had on their organisations.

**Q** Admiral, in 2010 the London Treaties, still known as the Lancaster House Agreements, were signed by France and the UK. Four years later, can you offer us a quick update on the progress achieved within the Agreements by the Navy under your command?

**UK** When viewed through my lens as First Sea Lord, I think the 2010 treaties have turbocharged the bilateral relationship between the Royal Navy and our good friends in the Marine Nationale. The signing of these far-reaching agreements provided a real statement of strategic ambition for our future naval co-operation.

Several years later what I see, on a daily basis, is the practical delivery of that ambition – at the strategic, operational and tactical levels. Our extensive co-operation off the coast of Libya three years ago and the development, establishment and working up of the Combined Joint Expeditionary Force (CJEF) are high-profile illustrations of the progress we have made together. But there are many other less-visible examples of the maturity of our partnership, like Lynx embarkation, personnel exchanges and progress in the equipment arena, all of which I'll touch on later. And there is much more still to come on this journey together – for example, CJEF is planned to become operational in 2016 and our carrier co-operation will intensify as the Queen Elizabeth-class carriers put to sea and in due course embark air groups.

**UK** The Lancaster House Treaties were rapidly put into practice through the co-operation between our two naval forces during our missions in Libya in 2011. This proved to be a success, in some ways a baptism of fire, and initiated a powerful dynamic that we continue to maintain. It was followed by the 2012 Corsican Lion exercise, which enabled us to put in place

*the first milestones for the CJEF, scheduled to be operational in 2016. We are still working on a number of fronts. I am thinking in particular of information-sharing and establishing shared protected communications. And we are making progress. This is clearly demonstrated by the assignment of a British officer to navy operations general staff, responsible for scheduling French navy activities, and another officer to the post of Battle watch captain on board the Charles de Gaulle aircraft carrier. This officer is working at the core of our operational set-up.*

**Q** Co-operation within naval programmes has not always been crowned with success. Will there be any capability renewals which will be more aligned in future years? If so, are there possibilities for mutualisation and complementarity?

**UK** Let me start by saying that, having plied my trade as a naval aviator, I spent a couple of very enjoyable years flying the Lynx. This long-serving helicopter has been the airborne workhorse for the destroyer and frigate fleets of both the Royal Navy and the Marine Nationale. So the Lynx success story demonstrates that mutual co-operation and future capability alignment already has a fertile soil in which to take root and grow. Indeed, only in March, an announcement was made about our joint procurement of a future anti-ship missile system, which in the Royal Navy's case will be operated by its new Wildcat helicopter, our replacement for the Lynx.

And there are other exciting future opportunities for aligning our capability renewals. Let me explain why. Increasingly, our systems need to be open, both commercially and technically. Why? Because that enables the rapid connectivity and upgrade of technology and that, in turn, enables us to maintain a



● First Sea Lord Admiral Sir George Zambellas

credible, evolving and battle-winning edge. The opportunities to be seized through open architecture are perhaps greatest in the commercial world of remote, or unmanned, systems. For the Royal Navy, our future Mine countermeasures and Hydrographic Capability (MHC) programme generates an early requirement for exploring the utility of unmanned vehicles and the possibilities created by open architecture. Our joint maritime mine countermeasures programme is helping to fuel our mutual ambition in this field.

**UK** The programmes we are discussing include, in particular, the light anti-ship missile. France and the UK are also jointly committed to the SLAMF programme, under the auspices of OCCAR. Further on down the road, we are thinking about shared programmes in the fields of undersea warfare, and future cruise or anti-ship missiles. Here I think there are promising opportunities for co-operation.

**Q** Are you currently lacking any capabilities, or might you be lacking some in future years? What synergies might therefore be foreseen with your ally?

**UK** We are working hard in the Royal Navy to regenerate our carrier strike capability. Importantly, this will not be a like-for-like replacement of the carrier strike delivered from the Invincible-class carriers, but a return to the scale of fast-jet operations last seen in the 60s and 70s – a return to mature, credible carrier strike.

This flagship naval programme is creating a significant maritime opportunity for France and the UK to collaborate, not least because aircraft carriers will sit at the heart of the CJEF's maritime element. Indeed, as the UK continues its apprenticeship in rebuilding its carrier strike capability, we are already benefiting from the generous assistance of both our French

and US allies. By 2020, we aspire to commence operating a common carrier strike group – using a UK or French carrier. This is a precious goal for both of our navies. But we do not need to wait for HMS Queen Elizabeth to become operational to realise this vision. We are exploring the art of the possible with the integration of a Type 23 frigate or Type 45 destroyer within the French Carrier Strike Group later this year.

**UK** Over and above the programmes in place, I think that we must indeed reason in terms of capabilities. France has an aircraft carrier, a key resource in our defence, significantly boosting our intervention capabilities. Numerous missions have shown the advantages of having a platform for the unrestricted deployment of war planes in the immediate vicinity of the majority of nerve centres throughout the world. But our aircraft carrier is unique, and during maintenance periods we lose this precious deployment capability. The French Navy and the Royal Navy therefore have a vested interest in possessing interoperable resources. For this reason, by 2020, we are working to provide a common naval air group for an aircraft carrier and an air crew that could be alternately provided by France or Great Britain. This is an ambitious project, but it seems to me that this arrangement has a number of advantages both for ourselves and for our British allies.

**Q** Aircraft carrier design choices have been made which don't appear to facilitate further interoperability, especially for the embarked Naval Air Group. Can you comment?

**UK** It is certainly true that the French Rafale fast jet will not be able to operate from the new Queen Elizabeth class. But that is to view UK-French aircraft carrier interoperability through a very narrow lens. Let me explain why.

Firstly, the Queen Elizabeth-class aircraft carriers will not perform only in a fast-jet carrier strike role. They will also have a Littoral Manoeuvre capability. That means that even if French fast jets cannot currently operate from a Queen Elizabeth-class carrier, French helicopters should.

But there is a further important point to make. What we also need to consider is future interoperability – and I mean a long way into the future – because a key feature of these platforms is their longevity. The Queen Elizabeth-class carriers will have a lifespan of over 50 years. So our professional horizon stretches many decades ahead for the naval aviation which will be conducted from this floating airfield. That is a long time and that offers a lot of opportunity to further interoperability in the years ahead. Perhaps I can really make the point in these terms. Given that the last Commanding Officer of the new HMS Queen Elizabeth won't be born until about 2023 – or join the Navy until about 2044 – the technology that will be at our disposal is only limited by our imagination.

**UK** Interoperability can take a number of shapes and forms and its most successful implementation does not constitute an end in itself. It is a means. We each have our own constraints and cultures. Therefore, some are inclined to go in one direction, others in another. It is not a question of knowing which way to go but of having a common direction and co-ordinating interactions. The same applies for naval resources.

In this case, the aircraft carrier, irrespective of its design, is a major resource that cannot be separated from its naval air group. Numerous combinations are possible within this arrangement, whether in terms of general staff or complementarity

*of vessels or aircraft, whatever their nationality. The deployment of a British Lynx to Surcouf at the beginning of 2013 is a fine example of successful integration. The British pilots had the same responsibilities and rules of engagement as their French counterparts. The very least we can say is that this example was conclusive. That is how I see co-operation on resources.*

**Q** Efficient co-operation occurs through action ashore by the men and women of your Headquarters and via those at sea. Can you explain to us specifically how that happens today between the two navies?

**UK** Yes, certainly. Let me give you a couple of specific examples. First, there are 14 exchange posts. Why do I mention them? In part, because these exchanges are of real strategic significance: they inform political communications at inter-governmental level. They are also strategic in another sense. These exchange posts can be found at not just the tactical and operational level, but in the very highest headquarters formations. For example, a French *Capitaine de frégate* is one of my officers on the Naval Staff here in the British Ministry of Defence, and I rely upon him to help me in delivering strategic effect for the Royal Navy and the Marine Nationale.

A second example is last year's embarkation of a Royal Navy Lynx flight from 815 Naval Air Squadron in a French frigate, FS Surcouf. This was not window dressing. The integration of a Royal Navy flight occurred during a demanding operational deployment to the Middle East where the ship was engaged in counter-piracy operations. And, on the reverse side of the coin, a French Flight Observer is deploying in HMS Diamond. I expect these types of exchanges to become regular and routine.

So what is the value of all this activity? It is helping to deliver genuine interoperability, but it is also helping to promote an instinctive cultural awareness of each other. That is not just valuable, it is essential.

**UK** Exchanges between navies on both sides of the Channel are intensifying. Once again, the results are promising. Three British officers are working in the naval general staff in management positions, and one of them is working in my own office. Five officers are at this time working within the French CTG, and in particular on board the Charles de Gaulle. These officers have exactly the same duties as their French counterparts. Mutual trust is very strong.

In reality, we are increasingly observing that the British officers adapt to working with us immediately; we have the same approach to combat and the same procedures, which makes things a lot easier.

**Q** In terms of the activity of operational preparation and that of operations, much has been said about CJEF. Having declared the ambition, do you think you are on track to meet the key waypoints and deadlines with regard to naval aviation?

**UK** The ambition to achieve a high degree of co-operation and, as far as possible, interoperability in carriers and naval aviation is crystal clear in the Lancaster House Agreements. But, as we have already discussed, I see interoperability and co-operation as meaning much more than just flying fast jets off each other's ships; it's about improved joint long-term planning and, where appropriate, pooling and sharing so that we offer more efficient use of our capability, both individually and collectively. Of course, for the UK, our deadlines will inevitably be driven by the timeline for bringing HMS Queen Elizabeth into service,



● Helicopter carrier HMS Illustrious replenishes at sea from French supply ship FS Somme during the British warship's Cougar 13 deployment last year. Not only is it prudent to keep the fuel topped up, but such manoeuvres also give British and French sailors the opportunity to work together

Picture: PO(Phot) Ray Jones



# Formidable...'

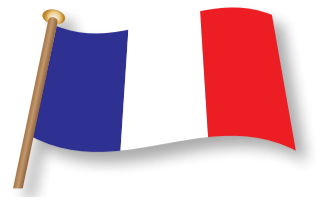

but in the meantime we will work with the aviators in the Marine Nationale to deliver a validated CJEF capability in 2016.

■ ■ Yes. As I said, the objectives identified during the Corsican Lion exercise are well on the way to being achieved.

Sometimes we encounter setbacks due to budgetary or operational constraints in our two naval forces, but this does not stop us from taking the project forwards. If we are to validate the concept during the Griffin Strike exercise in 2016, then it is our duty to seize any opportunity to train together, which is what we already do.

■ Do you think that the French-UK naval partnership should serve as the model or driving force towards the creation of a European Maritime Force? If yes, in what way?

■ Well, the idea of a European Maritime Force is of course a political, rather than a military, concept so it would not be appropriate for me to stray into that space. But what I can say, from a military perspective, is that the French-UK partnership forms the core of European maritime operations. For example, it is manifested in the leading roles played by UK and France in the conduct of Op Atalanta. Our common heritage also gives us a role together in many areas of the world. For example, we would like to develop our co-operation in the Atlantic, in the tropical belt which stretches from the Gulf of Guinea to the Caribbean, and earlier this year HMS Portland and FS Birot operated together off Ghana. And, as Libya powerfully illustrated, we are both from nations whose politicians recognise the utility of military force and have been prepared to take tough decisions on when to use it.

■ ■ I think we should move forward in small steps. Rather than seeking to build a 28-nation common force straight away, we need to make the bricks that can then be put together with other bricks. Franco-British co-operation is an essential brick, which could be used effectively within the framework of a more ambitious project, which we all aspire to. However, it is worth noting that many things are already being done. The majority of European navies all work with the same procedures, laid down by NATO. If the shared political will is there, we know how to work together. The European Atalanta anti-piracy mission in the Indian Ocean is the best example of this.

■ In reality NATO has always been the reference

organisation. How do you see your Navy's position and that of the French-UK partnership in NATO maritime operations, whose command is now centred at Northwood? What consequences might one expect from the development of a more strictly European identity in this context?

■ ■ What is plain is that, with the US rebalancing to the Pacific, our principal strategic partner is relying upon the UK and France to lead other European countries in sharing the burden of defence and security in Europe and its neighbourhood. In that grand strategic sense, it really does not matter whether we are doing so under a NATO or an EU banner. The strategic effect which is achieved is the same. For example, Operation Ocean Shield, a NATO mission, and Operation Atalanta, an EU mission, both have the same purpose – to hold in check the lawlessness of piracy in the Indian Ocean.

We are sharing that burden not just through our participation in NATO and EU maritime operations, but through our leadership within NATO too. That means we both share a maritime voice that is heard across the global commons. A good illustration of this can be found in the NATO Maritime Command construct which, since France rejoined the NATO integrated structure, has a permanent UK Commander and French Deputy Commander (both at 3\* level). That gives both of our navies a partnered professional authority within NATO maritime circles.

■ ■ We must not confuse the end and the means. NATO is a means. A European naval force is a means. These means are compatible. This is the advantage of a shared standard, NATO procedures that allow different units and general staffs to be combined at short notice. The question of the objective is really a political issue. It determines the means that are shared, and therefore the coalition formed to achieve these objectives. The way I see it, it is not a question of competition, but rather of complementarity.

■ France and the UK each maintain a strong bilateral relationship with the US Navy, for historic reasons and those dictated by operational circumstance. How do you see the French-UK pairing amidst this 'team of three'?

■ ■ For me it is a case of 'all for one and one for all'. Our mutual relationship with the United States is a critical enabler for the



● French La Fayette-class frigate FS Surcouf as seen from her helicopter – a Royal Navy Lynx of 815 Naval Air Squadron – during the flight's deployment with the warship last year

UK-France relationship. A classic recent example is the support offered by the United States in niche areas, for example, area surveillance and air tankers, during the Libya operations in 2011. We are operationally meshed together. An illustration of this would be a UK frigate or destroyer deploying as part of the French Carrier Strike Group in a US-commanded operational theatre. And, as I've already touched upon, following its rebalancing to the Pacific, the US is looking to both the UK and France to help shoulder the NATO burden.

■ ■ Each of these three countries has strong relationships with the other two. This is in fact the case between the French Navy and the US Navy. Our air defence frigates were recently made responsible for the air defence of American air and sea groups, and vice versa. Mutual esteem is therefore very high and interoperability very strong.

These interactions are essential. Our three countries share global political aspirations and the same vision of the role the oceans play in their defence. It is therefore necessary that they be able to form alliances and seek support from one another.

The relationship between the French and British navies runs along these lines.

■ Admiral, to conclude, what is your Navy's interest in the French-UK bilateral co-

operation? What benefits are you seeing?

■ ■ In the modern era partnership and interoperability are precursors to delivering scale and effect. That is the strategic prize and so we are now putting the mortar of interoperability in place to cement the bricks of our partnership together.

So, if you were to ask me for my overall message, it would be this. The Lancaster House Agreements have generated a wave of ambition, authority and

opportunity that we are now riding together. That means I am looking forward to an ever-deepening partnership between the Royal Navy and the Marine Nationale, as we further develop our structures, capabilities and mutual cultural understanding in order to be able to work and fight more efficiently and effectively alongside each other.

■ ■ Essentially an operational interest, especially in this period of economic crisis which tends to limit the number of vessels and aircraft we

have. We must stick together and try to multiply the effects of our different resources.

The Franco-British partnership goes back a long way, and has seen both ups and downs. I feel that we are going through a period that is favourable for developing an 'Entente formidable' (tremendous entente), as it was pointed out at the signing of the Lancaster House Treaties. In some ways, this economic crisis is an opportunity to boost this agreement in a pragmatic way. Let's make the most of it!



● Chef d'état-major de la Marine Amiral Bernard Rogel



## FULLY LOADED?

Entitled UK Service personnel can **top-up** the private side of their WelComE account whilst serving on operational duty overseas.

Visit [www.mywelcome.co.uk](http://www.mywelcome.co.uk) for details.

WelComE Customer Contact Centre  
customer.support@mywelcome.co.uk  
[www.mywelcome.co.uk](http://www.mywelcome.co.uk)

**WelComE**  
Welfare Communications Everywhere

© 2014. All rights reserved. WelComE is a Registered Trademark of Astrum Limited.



## Making leaders is fun

MEMBERS of HMS Illustrious' ship's company spent the day at the Royal Navy Leadership Academy at HMS Collingwood in Fareham.

While alongside in Portsmouth for maintenance, 42 of Lusty's most junior crew members attended the one-day team building, communication and leadership skills course.

The morning was classroom-based, with the afternoon spent outside on the low ropes course; testing their nerves with various team building games.

Although the emphasis was on leadership and taking charge, there was plenty of laughter and enjoyment all round.

"It was a welcome change to spend a day off the ship, in a relaxed environment and mixing with people from other departments," said AB (CIS) Andrew Liston.

"I really like the direction that leadership is going in the Royal Navy. From what the instructor was getting across to us, the Navy is encouraging the development of coaching and mentoring skills; focusing on what you could have done better or got your team members to do differently. Overall, it was great fun."

WO1 (MEM) Ian Browne said "When we have the opportunity, the ship tries to get as many people away to undertake training courses, participate in sport and adventurous training; to spend time developing themselves both personally and professionally. The RNLA provides a fantastic facility in which we can really focus on the individual and bring on their leadership skills."

# Observer hailed for his 6,000 air hours

A ROYAL Navy observer has clocked up 6,000 flying hours.

If flying at the usual rate of 180 hours per year, an average aviator would expect to take over 33 years in a flying role to reach this milestone.

Lt Cdr Gordon Cook or 'Gordo' as he is known, has achieved this point after 28 years flying with the Royal Navy.

His achievement equates to 250 days solid in an aircraft. And with 6,000 flying hours Lt Cdr Cook has covered approximately 800,000 miles in a helicopter – enough distance to orbit the world 30 times, or cross the Atlantic Ocean 250 times.

Gordo's flying career within the Royal Navy started in February 1986, when he began flying training.

Since then he has been based at Royal Naval Air Station (RNAS) Portland, Culdrose and Yeovilton, predominantly on front-line Naval Air Squadrons.

He has accumulated the 6,000 military flying hours by operating in different variants of the Lynx, Sea King and Merlin helicopters as well as the Jetstream training aircraft.

He has served as a helicopter Observer with aircraft onboard HMS Argonaut, Brave, Boxer, Gloucester, Manchester and Cardiff, as well as being posted to Gibraltar.



● Lt Cdr Cook is met by colleagues from 815 NAS to acknowledge his achievement

He has also served as an Instructor for Lynx aircrew.

Currently Lt Cdr Cook is an Observer within the Maritime Counter Terrorism section on 815 NAS, based at RNAS Yeovilton.

When approaching this remarkable milestone, the humble and unassuming Lt Cdr Cook attempted to keep this feat

quiet from his colleagues...

...unaware that they had already noted the approach of this milestone and made sure of his surprise celebratory welcome on his Flight's return.

Lt Cdr Cook said: "I was trying to come in under the radar and thought I had got away with it so this was a complete surprise."

The celebrations followed Fleet Air Arm tradition by tucking into a very large cake.

Lt Cdr Cook is scheduled to retire from the regular Royal Navy service later this year, but he will continue to fly – as he has elected to enrol as a member of the Royal Naval Reserve, where he will remain as a Lynx Aircrew Observer.

## Veteran caterer retires

A SWANSEA-BASED Falkland Islands veteran canteen manager has marked the end of his service on Royal Navy ships with a presentation from his former Commanding Officer, Admiral the Lord West of Spithead.

Nigel Woods, 55, a former pupil at Wolverly High School in Kidderminster and a resident of the village of Crofty near Swansea, is the canteen manager on board HMS Argyll.

He served under Lord West on HMS Ardent during the Falkland Islands conflict in 1982.

Nigel, who has served in 17 ships, receiving five operational medals, was presented with a certificate of valediction by Lord West, signed by the Second Sea Lord on behalf of the Admiralty board, to mark his selfless service over the past 35 years.

Nigel said: "The camaraderie on board and the opportunities to see different countries are fantastic; for me the highlight was visiting the Pacific Islands, such as Tonga, in 1995 with HMS Monmouth."

Nigel joined the NAAFI aged 19 and a few years later was involved in the Falkland Islands conflict serving onboard HMS Ardent under Lord West.

One of the bombs which struck the ship hit the canteen.

"The attack on HMS Ardent is something that will stay with me for the rest of my life," added Nigel. "The experience is part of what has driven me to continue serving on Royal Navy ships, and it was only because I was working in the Sick Bay, away from my nominated action station, that I survived."

## Get ahead in your career with the University of Leicester

Our flexible degrees and courses can give you the platform to launch a new career. You can study through distance learning giving you the flexibility to learn in a location that suits you. We are an ELCAS approved learning provider with over 25 years' experience delivering quality distance learning courses that can help you get ahead.

### Study subjects including:

- Criminology
- Employment Law
- Management
- Human Resources
- Media and Communication



Get ahead, get in touch

[www.le.ac.uk/distancelearning](http://www.le.ac.uk/distancelearning)

T: +44 (0)116 252 5377

E: [dladvisers@le.ac.uk](mailto:dladvisers@le.ac.uk)



University of Leicester

## Top honour for CO

THE FORMER CO of 820 NAS, Cdr Chris Godwin (right), has been awarded the Queen's Commendation for Valuable Service.

Merlin Squadron, based at RNAS Culdrose in Cornwall, was on operations in the Middle East between December 2011 and April 2013, at immediate readiness to provide protection for Royal Navy shipping during maritime operations East of Suez.

Part of the citation for the award read: "Cdr Godwin not only delivered operational commitment with his Merlin Mk 1 anti-submarine helicopters, but significantly increased their flying rate and availability.

"Having identified best practice to optimise the squadron's personnel changeover profile, he skillfully balanced the concurrent operational demands in theatre, with flying currency for the remainder of the Merlin Force back at Royal Naval Air Station Culdrose.

"Under Cdr Godwin's leadership, 820 Naval Air Squadron has delivered unprecedented levels of aircraft availability, operational output, strategic relevance and success: his squadron admire, respect and work extremely hard for him – he is thoroughly deserving of national recognition."

Cdr Godwin and his family live in Cornwall, but are currently based overseas as he has recently started a position within NATO.

He said: "I'm delighted and incredibly humbled to have been awarded this Queen's Commendation for Valuable Service.

"I do consider it an award which falls to the efforts of 820 Naval Air Squadron first and foremost, and if I could divide it by the 147 of them, then I would.

"I'm lucky enough that I was

at the top of the tree during a very busy, but ultimately hugely rewarding, period.

"Being the Commanding Officer at 820 Naval Air Squadron was one of the highlights of my career, and that's down to the men and women I had the honour to work with."

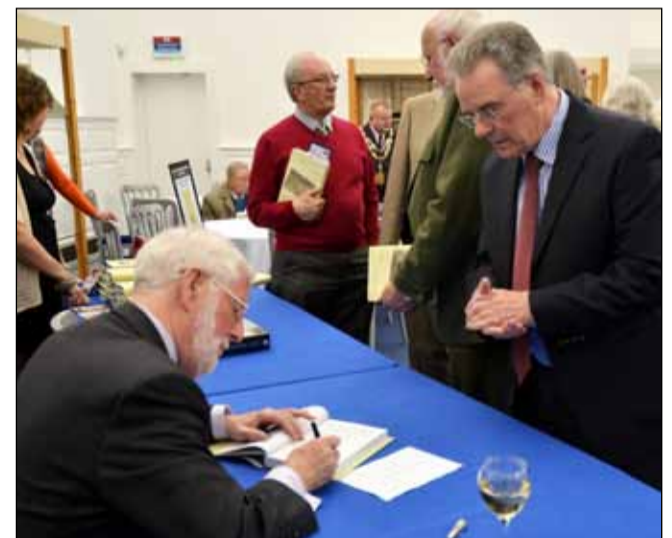

## Focus on dock

A BICENTENNIAL history of the Royal Dockyard of Pembroke Dock, written by former Head of Fleet Media Operations Lawrie Phillips (pictured signing book), was launched in the old Dockyard Chapel by former First Sea Lord Admiral The Lord West of Spithead.

"Lawrie Phillips who was born and bred just outside the dockyard walls, is a leading naval historian with a deep admiration for the Royal Navy and a profound understanding of its

business," said Admiral West in his foreword. "There could be no better man to tell the story."

The book, *Pembroke Dockyard and the Old Navy*, covers in detail the 260 ships, including five royal yachts, built at Pembroke Yard between 1814 and its closure in 1926.

A review will appear next month.

Lawrie is now working on a new edition of his widely-known reference book *The Royal Navy Day by Day*.



# Sealing friendship

AN AWARD marking the friendship between the Band of Her Majesty's Royal Marines Plymouth and a 93-year-old veteran of the Arctic Convoys has been presented for the first time at HMS Raleigh.

Eric Greenleaf, a former Royal Marines Musician, was invited to the Band Complex at HMS Raleigh to personally present the prize to the first recipient, Musn Charlie Irons, who hails from Exeter.

The Band has developed a close bond with Eric, who lives on the Barbican, and as a tribute to the musicians of his own generation and his links with today's musicians, he kindly donated the prize to be given annually to the most improved member of the Band.

Maj Jason Burcham, the Plymouth Band's Director of Music, said: "We've been honoured for the last couple of years to get to know Eric and he has become an honorary member of our band."

"We're very proud of that friendship and we were looking for a way to mark it. Ultimately we decided that an award of some

description would be the most positive and suitable way of illustrating the relationship that has developed between us."

Eric is in regular contact with the Band and has attended numerous concerts and other events as their guest. Last year the Band arranged for him to be presented with his Arctic Star Medal by the Second Sea Lord during a passing-out parade at HMS Raleigh.

Eric said: "I wanted to donate a prize because of all the kindnesses that the Royal Marines Band Plymouth and the Band Service as a whole have done for me over the years."

"Every year the name of the most progressive musician will be added to the plaque. I'm very pleased that Charlie was chosen to be the first recipient."

When he first arrived at the Royal Naval School of Music at the age of 14 years and eight months, Eric could only play the harmonica. During his time at the school he was taught to play the clarinet and the viola, and went on to complete 26 years as a

Royal Marines Musician, leaving the Service in 1960.

Eric served throughout World War 2. He completed 15 Arctic Convoys on board ships tasked to protect merchant shipping delivering vital supplies to the Soviet Union.

Eric rejoined HMS Cumberland in Buenos Aires. The ship, along with three other Royal Navy warships, engaged the German pocket battleship Graf Spee at the Battle of the River Plate in 1939 before her captain famously scuttled the German vessel in Montevideo Harbour.

In 1942 Eric was sunk after leaving Ceylon on an Australian ship, having played at an Admiral's reception ashore.

He spent nine hours in the water clinging to a piece of deck with a fellow band member who was covered in oil and couldn't swim.

As the war against Germany was ending Eric was drafted to HMS Newfoundland in the fight against Japan.

Five years later he saw further action in the Korean War.



● CPONN Kaur, CPOMT Wilson and CPONN Swain

## Medics promoted

THREE Senior Rates working as part of the PCRf Medical Team aboard RFA Argus have been promoted.

Reservist PONN Balbir Kaur was promoted to CPONN, and POMA (ODP) Carolyn Wilson was promoted to the new Medical Technician Operating Department Practitioner cadre as CPOMT (ODP), by Surg Rear Admiral Calum McArthur.

PONN Fiona Swain was also promoted to CPONN by PCRf Commanding Officer Cdr Danny Follington.

CPONN Kaur works as a Senior Trauma and Orthopaedic Nurse at Birmingham Heartlands Hospital, and joined the RNR Medical Branch 14 years ago.

She said "Since joining I have deployed to Iraq and twice to Afghanistan, as well as exercising as part of the PCRf on RFA Argus, and on HMS Illustrious. I regularly attend training nights at my Reservist Unit, HMS

Forward, and would thoroughly recommend it to anyone."

CPOMT (ODP) Wilson joined the RN as a Medical Assistant in 1997, and has spent time working with various Royal Marines units, served at sea on HMS Enterprise and Illustrious as well as completing operational tours of both Iraq and Afghanistan.

She said "I have thoroughly enjoyed my time as an MA and have always been very proud to be part of the medical branch."

CPONN Swain works as Senior Nurse for the Maritime Mental Health Team and is 2iC for the Department for Community Mental Health in Portsmouth.

CPONN Swain said "I have thoroughly enjoyed my time onboard RFA Argus, it has again been a great opportunity to forge increased awareness of Mental Health Provision and work alongside my tri-service counterparts."

## Award for outstanding rating

A YOUNG LAET has been recognised by his Cdre, Jock Alexander, for an excellent contribution to the implementation of change.

LAET Colin Drysdale, 24, from Alloa in Scotland, has been awarded the Commodore's Award For Excellence (CAFE) following his secondment to the RNAS Yeovilton Change Management team in October 2013 to assist with the day-to-day practical implementation of various changes across the base.

LAET Drysdale said: "I feel I have gained incredibly valuable life experience in a relatively short space of time - difficult to emulate elsewhere. Receiving this award has been a poignant way to round off my short career with the Royal Navy and I'm very pleased with what I have achieved overall."

LAET Drysdale has proved his worth providing support to both the Station Change WO Stewart Bryant and Plans Officer Lt Cdr Andy Morse.

WO Bryant said "He has proved to be an extremely reliable, conscientious and capable Junior Rating with an unwavering ability to get things done."



● Cdre Jock Alexander, LAET Colin Drysdale, and WO1 Stewart Bryant

## Dentists check for a smile

ROYAL Navy dentists will be out and about for National Smile Month, which runs from May 19 to June 19.

The campaign promotes three key messages: Brush your teeth for two minutes twice a day with a fluoride toothpaste; cut down on how often you have sugary foods and drinks; visit your dentist regularly, as often as they recommend.

The campaign hopes to raise awareness of health issues, and make a positive difference to the oral health of millions of people.

# 2004 TO 2014



Celebrating a decade of supporting defence and industry

- Reliability Centred Maintenance
- Marine Technical Support
- MMS Through-Life Management
- Safety Cases & Risk Assessing
- Project Management
- Material Assessments and Surveys
- ISO Consultancy & Certification

Find out what Xpedite can do for you  
[www.xpeditegoc.com](http://www.xpeditegoc.com) / [info@xpeditegoc.com](mailto:info@xpeditegoc.com) / +44 (0)1225 840832





# New President inaugurated



THE Duke of York performed the honours as the London home of the Royal Naval Reserve, **HMS President**, was formally rededicated following a major revamp.

The refurbishment of the establishment at St Katharine's Dock, a stone's throw from Tower Bridge, is part of an overhaul and rededication of RNR units across the land.

And in the case of President, the re-opening by the Duke coincided with a special award for the unit, which is home to 230 Naval Reservists.

President received a unit commendation in recognition of the ship's company's support to the Royal Navy over the past three years and their overall hard work and commitment, an award presented by Rear Admiral Chris Hockley, Flag Officer Scotland, Northern England, and Northern Ireland and Flag Officer Reserves and Regional Forces.

Other highlights of an evening to remember included the Royal Marines Band performing Beat Retreat, a Royal Naval Reserve Guard of Honour inspected by the Duke, and the formal lowering of the White Ensign during the Ceremonial Sunset.

It was all witnessed not just by members of President's ship's company but also an audience which included senior military officers, local dignitaries, employers, friends and families.

And last but not least, the evening served to mark the transfer of command from Cdr Eugene Morgan to Cdr John Herriman.

The former has been at President's helm for three years, during which time he's focused efforts on supporting the UK's operations around the globe and recruitment to the Reserve Forces.

Cdr Morgan also hosted the Queen during

her Diamond Jubilee celebrations and played a major role during the London 2012 Olympic and Paralympic Games, when the unit was used as a security base.

"Few words can readily express my pride in every member of HMS President's ship's company," the outgoing Comanding Officer told his men and women.

"Your hard work, selfless commitment and unfailing good humour have been the hallmark of your success and will ever continue to be so. Receiving a unit commendation is further testament to HMS President's standing within the Royal Naval Reserve and the wider Fleet."

Cdr Morgan continued: "Having spent nearly half my life at President, this has been the absolute pinnacle of passion and commitment.

"Each and every corner of the unit sparkled and I wish to thank everyone for your hard work and dedication in making it such a success."

Upon completion of the handover, the ship's company cheered Cdr Morgan as he departed from HMS President's jetty in the London University Royal Naval Unit patrol boat HMS Puncher.

In what has become an established tradition for outgoing President COs, he was given the honour of having London's iconic Tower Bridge open as he passed beneath.

The man who takes over from him was previously head of the Royal Naval Reserve Diving branch.

In his new role Cdr Herriman will make sure the London unit plays a leading role in ensuring that the Royal Naval Reserve achieves the growth targets set out in the government's Future Reserve 2020 policy.

Picture: PO(Phot) Alex Cave, RNR Air Branch

## King Alfred on parade for D-Day 70

HMS King Alfred's reservists have been invited to parade on Southsea Common on Saturday June 7 during Portsmouth's commemorations of D-Day.

For the King Alfreds, the major international event will also be used to celebrate the 20th anniversary of their unit's commissioning at Whale Island.

Former and serving members of HMS King Alfred's ship's company – or the RNR – are invited to join the parade, which will be beamed live on to huge TV screens sited on the Common and in the city centre.

For King Alfred, June 7 ends with a 20th birthday gala ball on Whale Island with friends, family and anyone who served at HMS Wessex, HMS Southwick and HMS Sussex – which merged in 1994 to form the present-day unit in Portsmouth.

For details about either the parade or ball, contact Lt Cdr Roy Malkin RNR on: roy.malkin101@mod.uk.

## Reserve head visits Warrior

THE head of the Maritime Reserve Cdre Andrew Jameson visited his men and women to see the key role they played in Europe's largest naval exercise, Joint Warrior.

Some 75 reservists from across the RN spectrum of expertise – amphibious and mine warfare, submarine operations, logistics personnel, watchkeepers, media specialists, communications and meteorologists – were mobilised for the fortnight-long war game which ran in the first half of April.

The commodore dropped in on HMNB Clyde to meet reservists involved with running Joint Warrior at the hub – the twice-yearly exercise is directed from a special operations centre at Faslane.

# Where's the (Wild)fire?

GOT any hose?

HMS Wildfire's Lt Jon Littman begins rolling out a firefighter's most important piece of kit as the Northwood reservist unit holds a combined training day with Hertfordshire Fire and Rescue.

Eleven sailors headed to nearby Rickmansworth Fire Station where Lt Littman and brigade watch commander Sean Good had some activities lined up to test command and leadership abilities of the respective personnel.

The mixed team from Wildfire consisted of a range of ranks and rates up to the unit's CO Cdr Stephanie Shinner.

So the sailors found themselves using lifting equipment to raise a car; controlling water with pumps and dams; entering and navigating smoke-filled buildings wearing breathing apparatus.

The climax of the day – in a state-of-the-art training facility at Watford fire station – was the most challenging exercise: teams had to negotiate their way blindfolded around a darkened building, requiring trust and teamwork.

"This was an excellent opportunity to learn from each other and develop RNR personnel in a challenging environment," said Lt Littman.

"Recent co-operation between the military and civilian authorities in the flooding has shown how important this joint training can be."

The activities taught the Wildfire team skills which can be transferred to a naval environment – but more importantly challenged their adaptability and ingenuity in situations which were new to them.

"Command, leadership and management are fundamental to our training as Maritime Reservists, but the opportunity to exercise those skills and adapt them working alongside the Hertfordshire Fire and Rescue



Service was a new and exciting innovation," said Cdr Shinner.

"I am enormously proud of my ship's company and I am indebted to the Hertfordshire

Fire and Rescue Service who could not have been more accommodating and enthusiastic; their professionalism and dedication is an inspiration."



## Hibernia's spring camp opens

GETTING their heads down on the range at Ballykinler Training Centre, two dozen miles south of Belfast, are reservists from units across Scotland, Northern Ireland and northern England.

The army camp on the south-east coast of the Province hosted three days of wide-ranging training for 90 RNR personnel.

The three days of instruction for the reservists – from HMS Hibernia (Lisburn), Calliope (Gateshead), Dalriada (Glasgow), Eaglet (Liverpool), Scotia (Rosyth) and Ceres Division (Leeds) – saw both personnel and instructors put through their paces.

They faced a force protection exercise, medical training, an assault course (pictured), field craft (shelter building, finding and cooking food, basic survival) and also made use of the indoor computerised firing range.

The three days were, says Cdr Ian Allen, Hibernia's CO, both successful and enjoyable for staff and those under training alike.

"This was an ideal opportunity to provide very useful general training to RNR personnel in a realistic environment," he added.

"This was also the first time training on this scale has been undertaken for the RNR in Northern Ireland and we were delighted to be able to host the Northern region units."

## Fox go a-hunting

HMS Flying Fox headed down the M5 to Bridgwater to try to convert rugby players and fans to a life in the Maritime Reserve.

As part of its recruiting push, the Bristol-based unit was out in force as Bridgwater and Albion RFC hosted Somerset Hornets.

AB Simon Davies, a reservist from Shepton Mallet, spoke to players and club members about the benefits of the RNR.

"As a reservist myself I'm passionate about going out to talk to people about what we do and what you can get

from the Reserves; personally, professionally and financially," he said.

"Rugby players are the perfect material for the Royal Navy, with their hearts of oak."

Lt Richard Burdett, from Taunton, added: "We have more people every month joining from across Somerset, and want to reach potential recruits in Bridgwater."

"After all, this was the home of Admiral Robert Blake, chief founder of England's naval supremacy."



**ACCOMMODATION**

**THE LADY HAMILTON**

~ Portsmouth ~  
Closest B&B to  
Historic Dockyard Gate

10 rooms, most en-suite  
Singles/Doubles/ Twins & Family rooms  
Freeview TV, Free Wi-Fi  
Tea/Coffee and full English Breakfast  
included  
Roast Dinners our speciality  
~ Free House ~

Tel: 023 9287 0505

**LOST MEDALS**  
REPLACED IN RECORD TIME

FULL-SIZE & MINIATURE  
3 DAY MOUNTING SERVICE  
**RAYMOND D HOLDICH**  
INTERNATIONAL  
P.O. BOX 2123, HOCKLEY,  
SS5 9AG  
**TEL. 01702 200101**  
[www.rdhmedals.com](http://www.rdhmedals.com)  
E.Mail: [rdhmedals@aol.com](mailto:rdhmedals@aol.com)



**The Royal Navy & Royal Marines Children's Fund**  
Registered Charity No. 1075015  
PATRON: HER MAJESTY THE QUEEN

**The RN & RM Children's is a National Charity based in Portsmouth. We care for children of men and women who have served or are serving in the Royal Navy and Royal Marines.**

Originally set up as an orphanage, we now assist children with a wide range of needs and at times of family crisis.

Applications can be made at any time. Those seeking assistance can contact the office direct for an application form:-

Monique Bateman  
or Laurene Smith  
RN & RM Children's Fund  
311 Twyford Avenue  
Portsmouth  
PO2 8RN  
Telephone: 023 9263 9534  
Fax: 023 9267 7574  
Email: [rnchildren@btconnect.com](mailto:rnchildren@btconnect.com)

**WALL SHIELDS OF ROYAL NAVY SHIPS**  
Hand painted on wooden base 6" x 7"  
**£53.25 including UK postage and packing**

REDUCED PRICES given for orders of 3 or more  
SPECIAL PRICES given for 10, 25, 50 and 100  
CRESTED TIES TO YOUR OWN SPECIAL DESIGN  
(minimum 36)

Specialist experience over 85 years  
**C.H. MUNDAY LTD**  
Rosemary Cottage, Churt Road, Headley,  
Bordon, Hants GU35 8SS  
Telephone: 01428 714971  
email: [enquiries@chmunday.co.uk](mailto:enquiries@chmunday.co.uk)  
[www.chmunday.co.uk](http://www.chmunday.co.uk)



**Worcestershire Medal Service**  
01527 835375

Full Size and Miniature Medals supplied and mounted for wear or display.

From the Boer War to current operations we keep one of the most comprehensive stocks of Medals and Ribbon in the UK

Contact us for prices, help and advice or a free brochure.

56 Broad Street, Sidemoor, Bromsgrove, B61 8LL  
[www.worcmedals.com](http://www.worcmedals.com) [wms@worcmedals.com](mailto:wms@worcmedals.com)

**Navy News Notice to Readers**

The publishers of Navy News cannot accept responsibility for the accuracy of any advertisement or for any losses suffered by any readers as a result. Readers are strongly recommended to make their own enquiries and seek appropriate commercial, legal and financial advice before sending any money or entering into any legally binding agreement.



**Exclusive deals for HM Forces.**

On car and van hire in the UK and Worldwide.

Book now on **0871 384 0004** or visit [europcar.co.uk](http://europcar.co.uk)  
Quoting promo code: **41717760**

Calls to 0871 numbers will cost 8 pence per minute from a BT landline, other networks and mobiles may vary. Calls may be recorded for training and monitoring purposes. Terms and conditions apply, visit [europcar.co.uk](http://europcar.co.uk).

**FIND A BOOK**

**HP BOOKFINDERS:** Established professional service locating out of print titles on all subjects. No obligation or SAE required. Contact: Moss Laird, Brig O' Turk, Callander, FK17 8HT. Telephone/Fax: (01877) 376377. [martin@hp-bookfinders.co.uk](mailto:martin@hp-bookfinders.co.uk)  
[www.hp-bookfinders.co.uk](http://www.hp-bookfinders.co.uk)

**MILITARIA**

**REGIMENTAL TIES, blazer Badges, Cuff-Links, Insignia, Medals, Cap Badges, Militaria.** £2.00 for list. Cairncross (Dep. NN), 31, Belle Vue St., Filey, N. Yorks YO14 9HU. Tel: 01723 513287 [www.cairncrossmilitaria.co.uk](http://www.cairncrossmilitaria.co.uk)

**CHAPLAIN RN VIDEO**

**THE ABOVE VIDEO** was made in 1986. If anyone reading this knows of a copy, please will they contact Reverend Mike Wishart on 01446 751600 or [michael.wishart@btpenworld.com](mailto:michael.wishart@btpenworld.com)

**ROMANTIC GIFT**

**DO YOU NEED** to prove to someone you love them? For the Ultimate Romantic Gift that your loved one has never received before go to [www.50reasonslove.com](http://www.50reasonslove.com)

**Tim O'Brien GVA**  
**ARTIST**

T: 01949 877590  
E: [tobrienart@hotmail.com](mailto:tobrienart@hotmail.com)  
[www.timobrienart.co.uk](http://www.timobrienart.co.uk)

**NAVY LISTS**

**NAVY LISTS** 1827 to 2011. View online: [www.NavyListResearch.co.uk](http://www.NavyListResearch.co.uk)

**Ballistic Weathervanes**  
A lifetime's story... captured on the breeze for years to come



Phone: 07403 033070  
Email: [ballisticweathervanes@gmail.com](mailto:ballisticweathervanes@gmail.com)  
Facebook: [Ballistic Weather Vanes](https://www.facebook.com/BallisticWeatherVanes)

**NAVY NEWS**

**Gifts Collection**

**Beanie Hat** - Made from 100% acrylic, these beanie hats are stylishly embroidered with the Royal Navy logo. One size fits all.

**£9.99** (includes P&P UK)



**Royal Navy Baseball Cap** - Made from 100% brushed cotton, this high quality Baseball Cap is embroidered with the Royal Navy logo and comes in navy blue with a red trim. Available in Adult size, buckle adjuster ensures one size fits all.

**£10.99** (includes P&P UK)



**Salty Jack** stands at 16" and has soft golden fur. He is kitted out wearing his number 8's uniform.  
**£33.50** (includes P&P UK)



**Big Charlie Bear** is 10" sitting. He has soft brown fur with beans in his hands and feet. Charlie wears a red fleece hooded top with the Royal Navy logo embroidered on the front.  
**£20.85** (includes P&P UK)

**Mini Charlie Bear** is 6.5" sitting. He has soft brown fur and comes in either a red or cream knitted jumper,  
**£13.45** (includes P&P UK)



Please send your order to:  
Navy News, HMS Nelson, Queen Street, Portsmouth PO1 3HH  
Along with a cheque made payable to: **HMG 1800**  
To pay by Credit/Debit Card, please call on 023 9272 6284 or 0494  
For orders O/S please add £3.00 to any item to cover P&P.  
[www.navynews.co.uk](http://www.navynews.co.uk)



## Reunions

**May 2014**  
HMS Hood Commemoration Service at St John the Baptist Church, Boldre SO41 5PG, at 11am on May 18. Guest preacher is the Ven John Green, Archdeacon Pastor of the Diocese of Coventry, former Chaplain of the Fleet and Current Honorary Chaplain of the HMS Hood Association. Members of the congregation are encouraged to wear their decorations at the service.

**June 2014**  
Royal Marine, Portsmouth Lodge No 6423: Hosting a combined meeting of RM Associated Lodges to celebrate the 350th anniversary of the Corps on June 21 at the Masonic Centre, Stakes Rd, Purbrook PO7 5LX, starting at 3pm. If any serving or retired RM Mason who is a member of a non-RM Associated Lodge would like to attend, contact David Barron on 07908 493772 or [david.barron@btinternet.com](mailto:david.barron@btinternet.com) or David Colbourne on 023 9226 2561 or [dcolbourne@lineone.net](mailto:dcolbourne@lineone.net)

**July 2014**  
BRNC Dartmouth Summer Term 1964 entry: Group celebrating 50th anniversary at the BRNC Summer Ball on July 11 welcome any other BRNC Summer Term 1964 entry to join us with wives/partners. Contact Doug Hamilton in Canada on 001 519 315 0190 or [hamiltons111@gmail.com](mailto:hamiltons111@gmail.com)

**September 2014**  
HMS Ark Royal Communicators 1973-1977 reunion in York from September 12-13. All Sparkers, Buntings and Gollies from that period welcome. Contact Jeremy Smith at [jsmith@greenford5.fsnet.co.uk](mailto:jsmith@greenford5.fsnet.co.uk) or 5, West Ridge Gardens, Greenford, Middlesex, UB6 9PE or 07789 375611.  
14th Carrier Air Group Reunion Association 20th reunion for anyone who served with 804 and 812 NAS, 1946-52,

HMS Ocean, Glory and Theseus, or at any other time, on September 20 at the RNA Club, Royal Leamington Spa. Details from Ken Lambert at [Lambert5nr@btinternet.com](mailto:Lambert5nr@btinternet.com) or 01733 234655.  
HMS Ocean Association 27th annual reunion and AGM at the Tillington Hall Hotel, Stafford, September 26-29. A warm welcome for all ex-Oceans (R68 or L12), families and friends, whether Association members or not. Details from Jim Hogan at [jimhogan1@sky.com](mailto:jimhogan1@sky.com) or tel 01253 795618.

**October 2014**  
HMS Arethusa Association 27th reunion at the Hillcrest Hotel, Cronton Lane, Widnes WA8 9AR October 3-6. Contact Tom Sawyer at [hmsarethusa38@btinternet.com](mailto:hmsarethusa38@btinternet.com), tel 01653 628171 or write to 6 Sycamore Close, Slingsby, York YO62 4BG.  
HMS St Vincent Association reunion at the Royal Beach Hotel, Southsea, from October 3-5. AGM at St Vincent College, Gosport, on October 4 at 11am. Details from Soapy Watson at [soapy\\_watson@hotmail.com](mailto:soapy_watson@hotmail.com) or 01329 310078 or through Isle of Wight Tours on 01983 405116 or see [www.hmsstvincentassoc.org](http://www.hmsstvincentassoc.org)

Nore Command RNPB Association annual function, October 5 in the King Charles Hotel, Gillingham, Kent. Open to all. Details: Orlando Jemmett on 01227 263691.  
HMS/M Repulse Reunion Association reunion October 24-27 at the Tillington Hall Hotel, Stafford. Contact Frank Scutt at [frank.scutt@gmail.com](mailto:frank.scutt@gmail.com) or see [www.hms-repulse.co.uk](http://www.hms-repulse.co.uk) or tel 01480 393228.  
Survey Ships Association reunion October 24-27, Best Western Coniston Hotel, Sittingbourne. Send SAE to the Secretary SSA, 8 Grosvenor Court, 74 East Lodge Park, Farlington, Portsmouth PO6 1BY, email [secretary@surveyships.org.uk](mailto:secretary@surveyships.org.uk) or call 023 9279 1258.

**November 2014**  
HMS Blake Marine Engineering Department tenth anniversary reunion November 1-3 in Gibraltar, open to all ex-serving members of Blake ME department. Visit [www.blakestokers.com](http://www.blakestokers.com) and use email address [info@blakestokers.com](mailto:info@blakestokers.com) for details of accommodation, or write to 3 Selwyn Avenue, Whitley Bay, Tyne & Wear NE25 9DH or tel: 07969 127939.

HMS Bulwark, Albion and Centaur Association centenary commemorations of the sinking of the fifth HMS Bulwark on the Medway 1914, to be held at Sheerness/Chatham. Enquiries to Leigh Easton, Glenmoray, Hayford Place, Cambusbarron, Stirling FK7 9JX or [ngfo@tiscali.co.uk](mailto:ngfo@tiscali.co.uk) Association open to anyone who served at any time on Bulwark, Albion and Centaur - [www.bulwarkassoc.co.uk](http://www.bulwarkassoc.co.uk)

HMS Diamond Association reunion, Royal Beach Hotel, Southsea, November 14-16. Contact Ray Shipley at [shipleyraymond@yahoo.co.uk](mailto:shipleyraymond@yahoo.co.uk), tel 01634 267084 or send details to 20, Winchester Way, Rainham, Gillingham, Kent, ME8 8DD.

## Deaths

Surg Rear Admiral Francis St Clair 'Frank' Golden. A GP who took a short service commission in the RN. After leaving first ship HMS Jaguar (South Atlantic and South America), where he captained the rugby team, he served at Helston from 1964. During his next appointment 1967-73 he discovered a refrigerated pool under the floor of the RN Air Medical School in Lee-on-the-Solent, used in WW2 to test aircrew immersion suits. Embarked on a 40-year scientific career, providing insights into the body's responses to immersion and cold exposure. INM for 12 years, responsible for RN lifejacket to be fitted with Perspex hoods and advocated that survivors should be lifted horizontally from the water; used himself as a guinea pig in trials and wrote, with M J Tipton, *Essentials of Sea Survival* (2002). Appointments included MOD 1985-86; Fleet Medical Officer 1986-88 and last Medical Officer-in-Charge RN Hospital Haslar. Surg Rear Admiral (Support Medical Services) 1990-93 then retired. Consultant in Applied Physiology Surrey University. 1994-2006 chaired the HNL's medical and survival committee; OBE in 1981; honorary physician to the Queen 1990-93. January 5. Aged 77.

Lord Moran. Called up as seaman 1943, served in HMS Belfast at the Air Defence Position behind the bridge and witnessed opening salvos of Battle of North Cape. As a Sub Lt he served in MTBs tending off German E-boats after D-Day. May 1945 stationed in Travemünde, Germany, and was accidentally wounded in the knee. Joined Diplomatic Service, taking him to Turkey, Tel Aviv, Rio de Janeiro, and to Washington DC as press attaché. Britain's Ambassador to Hungary 1973 (he learnt Hungarian) and later Portugal, then High Commissioner to Canada 1981-84. February 14. Aged 89.

Capt Michael J L Freeman. (Cmdr 1981-83) HMS Centaur, Tyne, Saker, and at Mercury, Raleigh, NATO Naples and Director Naval Signals. April 3. Aged 85.  
Capt Robert W Moland. DNOB and HMS Centaur, Tamar, St George, Dainty, Rapid, Dryad and DGNMT. Awarded MBE for services to KGFS. March 10. Aged 82.  
Cdr Hilary Foxworthy. Joined RN ca 1950. HMS Britannia as Lt (58-59), Naval Attaché in Turkey and Norway, received OBE, Trustee of the Admiral Duncan Camperdown Trust in Dundee. February 15.

Cdr Peter Watts. Midshipman (E) in HMS Loch Fada 1964 in the Far East. CINCNAVHOME staff, Rosyth Dockyard, FOSM Staff, HMS Neptune, Resolution, Valiant, Orpheus, Dreadnought, Revenge, Dolphin and RNEC Manadon. HMS Loch Fada Association. March 6. Aged 70.

The Rev Michael Harry George Henley. Known as Bishop Henley, Chaplain of the Royal Hospital School 1972-74 and Chaplain of the Fleet 1989-93, also Bishop of St Andrews, Dunkeld and Dunblane. March 21. Aged 76.  
Lt Richard Alexander 'Flash' Allen DSC. L earned to fly at Grosse Ile, Michigan, and continued training in Florida on Stearman biplanes, Harvards, Kingfishers and Buffaloes. Promoted Sub Lt on his return to UK, flew Fulmar and Wildcat fighters at Yeovilton. Joined 1832 NAS at Eglinton 1943, later joining 842 NAS in escort carrier over Biscay; awarded a DSC. 1945 he joined carrier Campania with 813 NAS en route to Murmansk, where he downed a Junkers 88; for his Arctic patrols he was awarded a Bar to his DSC. January 29. Aged 92.

Lt Cdr Herbert J Lavers. Served HMS Vulture and Nabstock. March 6. Aged 99.  
Supt Nursing Sister Anne Farrell QARNNS. Served Naval Hospitals Haslar, Malta and Plymouth and MDG(N) staff. March 11.

Lt (S) Kevin de Lacy (Writer). Served Ark Royal, Cochrane, Falcon and Ulster Div RNR. March 31. Aged 86.  
Lt Cdr David H C Davenport. Served Heron, Daedalus, Hermes, Goldcrest and Keppel. March 26. Aged 69.  
Lt Laurence 'Laurie' V Strong DSC RNVR. Joined RNVR at outbreak of war, training as a signalman, later learning navigation. Commissioned 1940, served in Boadicea on convoy duty in the Atlantic and

**March 2015**  
HMS Ariadne annual reunion, Forest Pines Hotel, Broughton, Lincs DN20 0AQ March 13-15 2015. Deposit of £20pp to Sally Clarke at 'Just for Groups' tel: 01603 886740. Total cost is £99pp DBB. Former members of any commissions welcome for all or part of weekend. Contact Dave Sprinks on 01761 239221 or see Facebook [www.facebook.com/groups/37130765250/](http://www.facebook.com/groups/37130765250/) for details.

**April 2015**  
HMS Campbeltown first mine reunion April 3-6 in Guzz. Contact Florrie Ford on 07847391712 or email [cf002e5349@blueyonder.co.uk](mailto:cf002e5349@blueyonder.co.uk)

**September 2016**  
S58 Class: Calling Figsard Artificer Apprentices S58 Class - to commemorate the 50th anniversary of our joining the Royal Navy in September 1966, a reunion is to be held in September 2016. Those interested please contact Colin Stokes at [colinstokes@btinternet.com](mailto:colinstokes@btinternet.com) or tel 01489 581432.

on Convo PQ15 to Murmansk. 1943 sent to the Med where as CO of MTB 81 he sank U-561 in the Strait of Messina, picking up five survivors; awarded DSC. Reputedly one of the few men to have sunk a U-boat while going backwards. When US cargo ship John Harvey was bombed he towed the blazing ship, carrying mustard gas, out of Bari and helped rescue survivors; he was mentioned in despatches. February 25. Aged 96.

Lt Joe Dolman. Served 1948-85 HMS Liverpool, Tyne and Terror also Flag Officer (Air) Home, C-in-C Home Fleet, C-in-C Mediterranean and Recruiting Service. Awarded BEM for services training young officers at HMS Dolphin. Life Member of the RN Writers' Association. March 30. Aged 83.  
Lt Charles Hosegood RNVR. Served HMS Pegasus, Spey, Edinburgh Castle and Daedalus. February 17. Aged 93.  
Sub Lt (A) Crispin A Shorter RNVR. Served RNAS Eglinton (748 NAS) and Bramcote (1844 NAS). February 16.

Albert Joyner C/Sgt RM. Served 1930-56 HMS Dragon. 1932 helping hurricane victims in Cayman Islands. At the outbreak of war joined HMS Curacao on Arctic convoys, involved in evacuation of Singapore and supported Salerno landings 1943. President of Bradford District RMA, was Britain's oldest surviving ex-Royal Marine. Life Membership in 2013. Raised huge sums for RBL selling poppies. March 13. Aged 102.  
Sgt Harold H Hedge RM 5 Cdo. Soldier serving with Oxon and Bucks Light Infantry 1937, transferred to RA 1938. Involved in evacuation of Dunkirk 1940. Volunteered for 5 Cdo then joined No 3 Bde. His regiment saw action on French-held Madagascar 1942, also Lofoten Islands and North Africa, then spent 24 months fighting in Burma.

Bob Millard FAA. 1940 as a teenager in the Home Guard was approached to join the British Resistance Organisation. 1942 joined FAA as aircrew and was involved in anti-submarine patrols and attacks on Tirpitz off Norway, then served with British Pacific Fleet. 1945 survived kamikaze attacks on Formidable while supporting Okinawa landings. Member of the Goldfish Club (with bar), having survived landing in the sea twice. March 15. Aged 91.

Leslie 'Nicky' Harold William Paine. Volunteered for RN aged 19 then trained for the FAA at Gosport, Detroit then Ontario. Served at Arbroath, Benbecula, then joined 835 NAS aboard HMS Nairana flying night strikes on Norwegian supply ships in a Swordfish; later he escorted Russian convoys. His book, *Memoirs of a Swordfish Man* published 2013. December 2. Aged 92.  
Euan Melvin 'Mitch' Mitchell WO Wtr. Served 1959-86 at Ganges and Hermione, Owen, Terry, Dolphin, Daedalus, Nelson, Osprey and Heron. March 30. Aged 74.

Gabriel Michael Batt CPO (Supply). Served 1957-79 HMS Ark Royal, HMS Britannia, HMS Penelope and Glamorgan. Received Herbert Lott award, member of the Association of Royal Yachtsmen and was White Ensign (Bath branch) standard bearer for ten years. March 31. Aged 76.

William 'Bill' John Edwards PO AFA. Served 1947-54 HMS St George's, Vengeance, Theseus, Siskin, Condor, Merlin, Kestrel, Daedalus and Heron. Member Birmingham branch FAA Association 1970-99 and 2011-14. March 15. Aged 84.  
Cyril D Wheeler LSBA. Served 1950-57 in RN Hospitals Chatham, Haslar, Tamar and Stonecutters Island HK. RN Medical Branch & Sick Berth Staff Association. March 8. Aged 81.

Ronald 'Ron' Godrich Coder. Served 1942-46, mainly Eastern Fleet including HMS Queen Elizabeth and Haitan. Burma Star Association, Queen Elizabeth Veterans and RNCA. April 2. Aged 89.

## Ask Jack

HMS Burghead Bay 1957-58 working out of Simonstown. Doug Turk has interesting info for Donald Kent. Contact him on 01252 378629 or [doug.turk@ntlworld.com](mailto:doug.turk@ntlworld.com)

Chaplain RN Video. If anyone knows where the Rev Mike Wishart might obtain a copy of this 1986 video contact him on 01446 751600 or email [michael.wishart@btopenworld.com](mailto:michael.wishart@btopenworld.com)  
John Dennis Kane: John Kane, son of John Dennis Kane ('Pete' or 'Knuckle') is desperate to contact Mike ('Ollie') who served in both Black Swan and Birmingham with his Dad in the 50s. They were best friends, as were their wives Joyce Kane and Ollie's wife Gwen. Contact John Kane at [j-kane@ntlworld.com](mailto:j-kane@ntlworld.com) or tel 0115 913 3295.

John Hudson: Sue Cloud is looking for John Hudson, brother of Samuel Hudson, last known address in the Portsmouth area. Contact Sue Cloud (nee Hudson), daughter of Samuel at [suecloud42@hotmail.com](mailto:suecloud42@hotmail.com) or tel 01760 441110.

Survey Ships Association: Any past or present member of ships' company of any RN survey ship is eligible to join as a

full member. For info on membership and reunion send an SAE to the Secretary SSA, 8 Grosvenor Court, 74 East Lodge Park, Portsmouth PO6 1BY, email: [secretary@surveyships.org.uk](mailto:secretary@surveyships.org.uk) or call 023 9279 1258.

Brian Phillip Gregory: Would Mr Gregory, ex-RN, contact Mrs R M Tait nee Hill on 01642 675160 or 07548 791923.  
HMS Pagham became a Sea Scout HQ in Scotland in the 80s. Saw RN service from 1956 and after Sea Scouts disbanded was sold and decayed in Dunmore Harbour. Her bell hangs in a church in Pagham. We'd love to hear from old shipmates. Ken Rimell, [ken.rimell@vintagespirit.co.uk](mailto:ken.rimell@vintagespirit.co.uk) or 1 The Glade, Kingsbeach, Pagham PO21 4SD.

Tirpitz the pig: HMS Glasgow (C21/D88) Association would like to hear from any Red Cross member who has info on Tirpitz the pig. Tirpitz was left on board when Dresden was scuttled by the Germans in 1915 and was picked up by Glasgow and adopted as the ship's mascot. The pig was auctioned off for charity as pork in 1919 and raised £1,785 for the British Red Cross. Contact Allan Mercer on 0151 422 8026.

David Brazier. Served HMS Diamond, Eskimo, Ashanti, Defender, Antrim and Excellent. D-Boats Association. March.  
Alan Gittens. Served HMS Delight 1959-61. D-Boats Association. March.

**Royal Naval Association**  
Sidney Frank 'Joe' 'Sails' Elbro CPO Sailmaker. Served 1953-77 at St Vincent Boy 2nd Class (53-54) and in Implacable, Loch Ruthven, Victory, Glasgow, Bellerophon, Terror, Harrier, Drake, Royal Arthur, Ark Royal (62-64 and 70-77), Raleigh, Drake and Tyne. Sailing Instructor Jupiter Point 1975-77. Last official sailmaker to leave RN. 1st Lt TS Manadon SCC 1976-86. Member of Plymouth RNA and St Vincent Association. Contact SCA leader with the 1st Devonport Scouts for 40 years. January 27. Aged 76.  
John Edward 'Nobby' Naylor PO (SE). Served 1945-58 HMS Ganges, Ocean, Siskin, Warrior and Victory. British Nuclear Test Veterans Association and RNA. March 26. Aged 85.

Leonard 'Len' Veal AB Radar plotter. Served 1944-49 HMS Ganges and HMS Leander (Corfu Channel). Member of HMS Ganges and Corfu Channel Associations and Southport RNA. March 16. Aged 87.  
James Michael 'Mick/Mike' Hutchins AB. Member of TS Steadfast SCC 1946-51 and served RN 1951-63 mainly in Home Fleet, HMS Glasgow (54-55) and in Malta HMS Ausonia (61-62). Member of Kingston-upon-Thames RNA from 1986 (served on committee), also member of Worthing branch from 1997. November 17. Aged 80.

Major Alastair John Donald RM. March 14. Aged 80.  
Martin Philip Barker CPOMEA(M). Served 1967-90 including action on board HMS Avenger in 1982 during Falklands campaign. Cyprus RNA. March 12. Aged 63.  
Peter James 'Amos' Birks AB. Served 1957-72 HMS St Vincent, Vernon, Eastbourne, Cochrane, Pembroke, Redoubt, Bastion, Arethusa, Triumph and Chichester. Maidstone branch. March 17. Aged 72.

William 'Bill' John McWilliams. Ex-Army and Associate Member of Swaffham branch. February 23. Aged 83.  
George Hopkins PO Plumber (Artisan). Served 1940-46 HMS London, Battle of the Atlantic, Russian Convoys, South Atlantic and Indian Ocean. Margate branch. March 25. Aged 93.  
Peter Gordon Hutton PO Blacksmith 4th Class. Served 1942-46 at Chatham, HMS Saunders (Egypt), Triumph (1946) and RFR (1949-57). Herne Bay branch. March 3. Aged 89.

Robert 'Bob' Clothier FAA(T) Gunner. Southend RNA. March.

**Sea Cadet Corps**  
Keith Padgett PO (SCC). Joined Loughborough unit 2000, became LH 2004 and joined staff as a trainee instructor 2006, becoming a full PO 2009. Work took him south and he transferred to Trowbridge unit for a while 2011, but returned to Loughborough 2012. April 2. Aged 26. A more in-depth obituary notice can be found in the Sea Cadets section, page 44.

**Survey Ships Association**  
Ronald Jarvis L/S. Served in survey ships Scott, Franklin, Dalrymple, STU Pembroke, Sharpshooter and SML 324 (1948-54). 2013. Aged 88.  
John 'Rod' Pearson WO1(MEA). Served 1964-96 in Blake, Forth, Juno, Arethusa, Verulam, Urchin, Hydra (twice), Herald and Bristol; also Nelson, Tamar, Sultan, Sultan of Brunei's Navy and St Georges Barracks. 2013. Aged 69.

Michael 'Wiggy' Wiggins AB(SR). Served in Dampier, SML 326, Owen and Shackleton (1954-60). 2013. Aged 76.

Richard 'Ginge' Woodhouse WO1 (SR). Served 1961-96 in Mermaid, Hecate (twice), Fawn (twice), Egeria, Waterwitch, SCESU, Woodark, Endurance (twice), Hecla and NP1008. He was CPO (SR) with a survey boat party ashore surveying around Stanley in one of Endurance's red survey launches when the Argentinians invaded in 1982; he and his team hid the charts and launch which the Argentinians never found. The party joined up with the Royal Marines defending Government House where 'Ginge' was Sir Rex Hunt's personal bodyguard. August 2013. Aged 67.

**Submariners Association**  
B C 'Brian' Broadley AB. Submarine Service 1946-48 in Thermopylae. Southampton branch. Aged 86.  
L 'Les' Clarkson PO UC2. Submarine Service 1954-70 in Untiring, Subtle, Trespasser, Thorough, Telemachus, Turpin, Porpoise, RAN+Boat. Eastern States Australia branch. Aged 78.  
V B 'Victor' Collins LSM. Submarine Service 1947-53 in Tiptoe and Scythian. Southampton branch. Aged 85.

C 'Colin' Cunningham CPO WEA. Submarine Service 1964-85 in Token, Tiptoe, Resolution, Revenge and Repulse. Merseyside branch. Aged 69.  
J R 'John' Dansey PO ME. Submarine Service 1953-63 in Tally-Ho, Tudor, Talent, Ambush and Onslaught. Essex branch. Aged 80.

**Algerians Association**  
Brian Howarth Coder. Served in Bude. March 8. Aged 90.

Peter Tipler L/Seaman. Served in Bramble. March 8. Aged 82.  
Colin Statham AB. Served in Flying Fish. March 12. Aged 87.  
Fred Field Cook. Served in Moon. April 7. Aged 86.

**HMS Illustrious Association**  
Lt Cdr Roy Box.  
John William Baxter. On board with the Fleet Air Arm 1941-44. 2013. Aged 91.  
Bernard 'Jim' Gunter. On board with the Fleet Air Arm 1940-41. January.  
Tom Sumner RM. On board 1943-45. January 29.  
Ruth Ellis. Associate Member February 28.

## Sports lottery

March 15: £5,000 - AB J Grant; £1,800 - Cpl S Warren; £800 - AB G Bettley; £600 - LH C Reeves; £500 - Mne T Park; £400 - PO J Stewart.

March 22: £5,000 - Cdr J Phillips; £1,800 - AB A Smith; £800 - Mne J Ashford-Brown; £600 - PO S Bolton; £500 - Lt Cdr R Boyes; £400 - AB M Fell.  
March 29: £5,000 - AB L Cashman; £1,800 - Cpl S MacIntyre; £800 - Mne P Newland; £600 - Lt C Boarden; £500 - Mne N Crossley; £400 - AB T Nkonda.

April 5: £5,000 - PO S Hutcheon; £1,800 - AB2 A Clarke; £800 - Maj D Caldwell; £600 - AB2 J Keen; £500 - Lt Cdr G Hutton; £400 - AB A Lafferty.

## Competition

THE lucky winners of the *Command* game from the competition in our March edition were Mr P R Jones (Devon), Mr D Ramsbottom (Leeds), Mr S Myers (Plymouth) and Mr D Ledger (Portsmouth), who knew that the codename for the UK liberation of the Falklands in 1982 was Operation Corporate.

# Did you fly in this watery Wessex?

ON THE boulder-strewn bed of a flooded quarry, a diver approaches the body of a Wessex helicopter, the words ROYAL NAVY clearly legible outside the cockpit despite nearly a decade under water.

This is Fleet Air Arm Wessex XS122, which served on the front line and in a training capacity for more than a third of the 20th Century.

Today it sits 25m (82ft) deep in the quarry at Tidenham, near Chepstow, part of numerous training aids and underwater attractions at the National Diving and Activity Centre.

The slowly decaying frame of the helicopter was recorded on camera by diver and experienced underwater photographer Simon Brown, who's interested in hearing from anyone who has memories of the helicopter before it was lowered into the watery pit.

"The airframe is what is known as a 'diver distraction', giving the users of the quarry something of interest to explore whilst underwater," Simon said.

"The water is not always this clear, but the cooler winter months can see exceptional periods of clarity."

Wessex XS122 was delivered to the Navy back in 1963 and spent much of its active career with 819 Naval Air Squadron, frequently flying from the decks of Royal Fleet Auxiliary vessels, and later was transferred to 737 NAS in Portland before being used in a ground training role at HMS Sultan in Gosport.

At the end of 2007 the bulk of the fuselage - painted in Jungly green - was carefully lowered by crane and dive bags by a team of experts into the diving lake, where it rests along other 'underwater attractions' including a Land Rover, pleasure cruiser, amphibious vehicle and Ford Mondeo.

If you have stories of XS122, contact Simon via his website: <http://simonbrownimages.com/contact.html> or by phone 01252 653 759. For more details about the diving centre, visit [www.ndac.co.uk](http://www.ndac.co.uk).



**NAVY NEWS**  
**EYES FRONT**  
If you don't want to miss an issue

If you can't always find a copy of our newspaper, help is at hand! Complete this form and hand it in at your local newsagent, they'll arrange for a copy of each issue to be reserved for you. Some may even be able to arrange for it to be delivered to your home. Just ask!

Subject to availability  
Just ask

Please reserve/deliver my copy of Navy News on a regular basis, starting with issue:

.....  
Title ..... First name .....  
Address .....  
.....  
Postcode .....  
Tel. Number .....

**NAVY NEWS** Paper back copies are available from 2010. Editions from 1990 to 2003 in PDF format are available on a CD Please call 023 9272 6284 for details, or email [subscriptions@navynews.co.uk](mailto:subscriptions@navynews.co.uk)

**ENTRIES for the Deaths and Reunions columns, and for Swap Drafts, in June's Noticeboard must be received by May 12**

**NOTICEBOARD ENTRIES**

- Notices for this page should be brief, clearly written or typed and addressed to - The Editor, Navy News, MP 1.4, Navy Command, Leach Building, HMS Excellent, Portsmouth PO2 8BY, or email: [edit@navynews.co.uk](mailto:edit@navynews.co.uk). If you are sending your notice via email, please include your full address and telephone number.
- Reunions appear in date order, and requests to place an entry in a particular edition cannot be guaranteed.
- There may be a delay before items appear, due to the volume of requests.
- Entries on the noticeboard page are free to non-commercial organisations. Items pertaining to commercial work, books and publications for profit can only appear as paid-for advertising.
- The Editor reserves the right to edit or refuse publication of submitted notices.
- Space does not allow us to accept more than one free insert. Any subsequent notice will have to be paid for at advertising rates.



# 'It's in the nature of the British sailor to never let people down'

SENIOR officials from the Philippines have thanked the team in charge of the military's month-long response to the typhoon which devastated their islands last year.

A delegation from the republic – including the special representative of President Aquino Teofilo S Pilando Jr – visited the Northwood HQ to show their appreciation in person for the efforts of all three Services, and the Royal Navy and Royal Air Force especially.

Over 32 days last November and December, a 24-strong Joint Task Force Headquarters deployed to the Philippines to choreograph the actions of the UK military, working side-by-side with Filipino authorities, the Department for International Development and international agencies.

The response of Britain's Armed Forces included destroyer HMS Daring and later helicopter carrier HMS Illustrious, while the RAF committed C17 and C130 transporters to bring in and distribute aid.

Among the achievements of the Royal Navy's part in Operation Patwin, codename for the military's involvement, were:

- helping more than 22,000 people
- providing 16,000 litres of drinking water – enough to fill the fuel tanks of almost 300 family cars.
- delivering nearly 70 tonnes of food
- distributing nearly 400 shelter packs
- delivering 10,000 sheets of tarpaulin to help people rebuild their homes.

And the RAF provided

- more than 230 tonnes of aid – shelters, blankets, water purification tablets and the like
- 4x4 vehicles
- forklift trucks
- JCBs.

Cdre Clive Walker, who headed the Joint Task Force



● Cdre Walker discusses the aid effort with Sqn Ldr Davis Blakemore after an RAF C17 touched down in Cebu

Headquarters, said it was clear from the visit of the delegation to the Northwood headquarters that Britain's Armed Forces had "made a very significant impression on the people and the Government of the Philippines.

"It's pleasing and encouraging to hear that our contributions were so appreciated and had such a positive affect on the communities that we assisted."

As a nation, Britain was the biggest single donor to the international aid effort – £77m from the government, while the public gave an additional £85m.

Although such donations were altruistic on our part, the collective civilian and military response could reap benefits for the UK in the long term.

"We are now in the 'Asian century'. In a region where our trade links continue to grow, where some of the world's largest militaries rub shoulders and where natural disasters will continue to occur, Britain has demonstrated our commitment to be a force for good in South-east Asia."

Cdre Walker said in addition to the gratitude of Filipinos for Britain's help, the UK's response had impressed one of the senior US commanders in the region, Lt Gen John Wissler, whose III

Marine Expeditionary Force has frequently responded to disasters in the Pacific region and intervened in the aftermath of Haiyan.

"General Wissler was spellbound by the British response – he saw the hangar on Illustrious bustling with activity. He was struck by how competent and effective the UK's contribution was," said Cdre Walker.

"Not many nations can do what we did as quickly and effectively."

In the wake of Haiyan, experts from PJHQ and DfID have met their counterparts in Manila to discuss how the two countries could work together should a similar storm sweep through the islands again.

"Haiyan was the worst typhoon to hit the region. The poorest people were the ones who were most badly affected – communities were simply washed away," said the commodore.

Key to the British response in most cases, after initial life-saving efforts and fixing essential services, was restoring village schools.

"That meant children could not only resume their education, but it meant their parents could begin rebuilding their lives, their homes and try to get their livelihoods going again," Cdre Walker said.

With disaster-relief training carried out by every ship in the Royal Navy and aid regularly provided by its men and women in the wake of natural disasters in the Caribbean especially, the Senior Service's response to such events is well honed.

But Cdre Walker says there are still lessons to be learned from the effort in the Philippines.

"Clothing for our sailors – in the heat of the Philippines the Navy's blue working uniform wasn't particularly practical.

"And setting up food stations to provide sustenance ashore would be very useful.

"But otherwise, we did an outstanding job. It's in the nature of the British sailor to never let people down."



● Cdre Walker (centre) hosts Filipino dignitaries outside PJHQ's Northwood headquarters

## Job Opportunity

### The Perfect Aide-de-Camp (London Based)

The principal of a privately owned international investment group is seeking to appoint a highly motivated, competent individual to join his team of committed professional managers.

With business interests that currently reach across the European Union, North America and Canada, the Organisation now has ambitions to grow further, successfully undertaking projects and trading opportunities around the World and this opportunity will only be suited to a high performing, self starter.

There is a role for a capable, strong, highly motivated and well organised support player with appropriate experience, possessing a good command of the English language who is also numerate to join the Organisation as a personal aide to one of the Company's principals.

The successful candidate will be required to demonstrate their ability through a process of rigorous selection.

The pace and requirements of this post are extremely demanding with expectations beyond normal criteria. The commitment required is total and the position will only suit a highly dedicated individual, possessing a positive achiever's attitude, willing and prepared, if necessary at short notice, to accompany their employer on projects anywhere in the world.

The position available offers an opportunity for a highly skilled, broadly experienced and professionally accomplished personal assistant to act as an aide-de-camp for one of the business principals.

Tasks will include diary management, event coordination, management of records, gate keeping, general executive support, facilities management, oversight team coordination, arranging, initiating and managing projects together with accompanying senior executives on overseas trips. Driving the Principal and colleagues will be a routine element of the job. A vehicle will be supplied and a clean license is required.

Capable of operating effectively under pressure at all times, the individual chosen will be able to demonstrate loyalty with integrity, the ability to use their own initiative and at appropriate times lead and be accountable for specific projects of group activity. The individual will report directly to the one of the owner managers in a personal support capacity to deliver far ranging assignments.

This position is not for the faint hearted but for someone who relishes a challenge, wants more than the predictability offered by a regular job, is excited at each day's prospects and will be committed to deliver at the highest level.

Suitable applicants, ideally with a second language, will have developed their skills over a number of years, in like roles at other similarly based organisations and who feel they can command a highly competitive salary.

Applicants are asked to confirm that they:- Have a UK Passport. Have a clean Driving License. Are willing to travel and stay overseas. Reside within 1 hours commute time of central London. Have significant experience in a similar role.

Interested individuals should in the first instance send a CV to :- [r.havill@btinternet.com](mailto:r.havill@btinternet.com)



● Sailors and Royal Marines from HMS Illustrious begin carrying supplies, dropped off by Jungle Sea King, inland  
Picture: PO(Phot) Ray Jones, HMS Illustrious

**NAVY NEWS**

**SHIP of the MONTH**  
Collectors' Corner

Build an interesting and exciting collection of B&W and colour postcard-sized photographs of ships and aircraft of the Royal Navy and RFAs

1 YEAR'S SUBSCRIPTION

£15 UK £17 o/seas  
(12 for the price of 10)

Which includes ONE NEW postcard-sized photograph of our featured vessel or aircraft each month.

They can also be purchased individually for £1.50 each, (minimum of three).

Send Cheque/P.O. together with name and address of subscriber to Anne Young at:

Navy News, HMS Nelson,  
Queen Street, Portsmouth  
PO1 3HH

Or phone on - 023 9272 6284

Cheques made payable to: HMG1800

For orders outside the UK, payment is to be made by cheque/International Money Order in £ Sterling

**SEND SAE FOR PHOTOGRAPH LIST**  
(Older photographs will be in black and white)





**Project Faraday**

**Keep an eye out for our updates**

THROUGHOUT this month you will see several RNTMs issued that are connected with Faraday.

The first refers to the CPO to WO Provisional Examination (PE) syllabus and format.

The PE is an effective method of ensuring that you are technically capable for the Next Higher Rate.

Linking several Faraday initiatives is the Individual Competence Framework (ICF).

The RNTM issued on this subject aims to give you an introduction to how it is put together.

A more detailed RNTM will be issued later which gives further detail and how it will be used.

The final RNTM to be released this month concerns 'streaming'.

It is vitally important that all ET to CPOETs update your JPA with your 'streaming' preferences. This will help ensure your preferences are known by your career manager as people are 'streamed'.

What to do if you think you have been put in the wrong stream is included in the RNTM.

During April there has been a significant drive towards the delivery of full CIS / WE Integration.

As of March 24 2014 this initiative has become part of Programme Faraday.

Detailed work has started to identify how the merger of the CIS branch and the WE branch will be undertaken both at sea and ashore.

This is working towards full integration by April 2015. Revised career courses for the WE CIS ratings from AB - PO, which will include training for both the operator and maintainer roles, are being re-designed.

From April 2015 the intent is for all current CIS personnel selected for promotion to attend the appropriate re-designed WE CIS QC.

The Support Improvement Programme (SIP) is aimed at improving general engineering support.

The SIP Team is now collocated alongside the Faraday Team and this will give both programmes the ability to ensure that short term work being undertaken by SIP is aligned with the medium to longer term initiatives of Faraday.

Branch managers, Faraday and SIP will be conducting road shows during May.

These will give you a more detailed update and allow you to ask face-to-face questions on progress and the future. Dates and locations will be published locally when finalised.

The Faraday Team will let you know what has been happening during May in next month's article, so please look out for this regular feature.

If you have any questions or comments on Programme Faraday then contact WO1 Sharky Ward on 93832 7441 or via e-mail [navy-pers-faraday@wo1a](mailto:navy-pers-faraday@wo1a).

The Programme Faraday Intranet site can be found via the A-Z.

# Marines helping to fill gaps in ranks

*Drafty's corner*



OVER the past year the Royal Marines Corps has been directly supporting the Royal Navy in some of their pinch-point trades to help alleviate manning pressures wherever possible.

The opportunities have included Royal Marines clerks filling Royal Navy writer positions in Italy and Belgium, Royal Marines stores accountants filling Royal Navy logistics positions in Gibraltar, and Royal Marines information specialists filling roles at Royal Navy training establishments.

Currently assigned to Italy in support of NATO operations are general duties riflemen, physical training instructors, clerks and drivers with the potential for more specialisations to join the ever growing list.

With few permanent foreign positions available for RM Other Ranks, there has been little difficulty in finding willing volunteers to move overseas at short notice, often with their families, to experience the lifestyle of living abroad 'on Pusser'.

**Royal Marines Voluntary Outflow Rates**

The Royal Marines were formed on October 28 1664, meaning that this year sees our 350th birthday.

The original convening order stated that 1,200 land soldiers would be raised, held in readiness, and be distributed into His Majesty's Fleets and prepared for sea service.

Now 350 years later, and with a current liability of 6,931 regulars and 648 reserves, the Corps is currently within what is known as "manning balance" - the point at which its 'strength' (or 'hot bodies') is within one per cent of its manning liability.

We are also experiencing an unusually low amount of ranks leaving the service, Premature



● Above: Royal Marines PTIs are helping to relieve manning pressures, with one group in Italy supporting NATO.  
● Left: The 1664 challengers are marking the 350th anniversary of the Corps

Royal Marines everywhere; your 'seven clicks to freedom' isn't necessarily reversible.

**Royal Marines Careers Advice**

With the introduction of the New Employment Model and pension scheme, the importance of taking charge of your career at the earliest opportunity is paramount. Your choice of specialisation could well affect your future potential reach.

The Naval Personnel Team (Royal Marines) (NPT(RM)) is based in West Battery on Whale Island in Portsmouth, and is made up of a wide range of specialisations and ranks, ranging from Sgt to Lt Col, with a combined length of Service in excess of 360 years.

NPT(RM) also specifically employs three Careers Advisors who provide impartial careers advice to any rank or Specialist Qualification. Make use of their knowledge and expertise and call if you need careers advice, whether in regard to information in this brief or any other career-related matters.

Contact details for RM careers advice		
WO1 Batchelor	NPT(RM)	93832 5531
WO2 Butler	CTCRM	93785 4222
WO2 Moxham	CTCRM	93785 4542

Voluntary Release has dropped to 4.8 per cent compared with nine per cent in the previous year.

The consequential effect of this is that those who submit their notice, but later change their mind and request to continue

to serve, are not necessarily being able to do so; each case is scrutinised by the Royal Marines Branch Managers with a range of factors considered before a decision is made on whether withdrawal of notice is permitted. The "so what" for

## Cash for centre Skills are critical

A HELENSBURGH families centre has benefited from £133,000 of government funding.

Braeholm is part of naval charity Aggie Weston's and prides itself in being a home from home to Service personnel and their families.

Situated in Helensburgh's East Montrose Street, since 1997 the centre has helped countless sailors, Royal Marines and their dependents.

Now, with the latest cash injection from the government, the centre has refurbished its facilities and also appointed a full-time Community Development Manager for Scotland.

The money came from £35M of LIBOR fines which the

government has made available for Armed Forces charities.

Jan Alpin, the newly-created Community Development Manager for Scotland, will spend time at Rosyth with the crew of the new Queen Elizabeth-class aircraft carriers and their families, as well as with Royal Marines from Faslane's 43 Commando and 45 Commando in Arbroath.

"The idea is to bring people together so they can create their own community and support networks," explained Jan.

The three star guest house has a total of 16 bedrooms. It also has a gym and sauna as well as an award-winning nursery.

For more information visit: [www.braeholm.org.uk](http://www.braeholm.org.uk).

THE Royal Navy requires personnel that have the ability to critically analyse and evaluate information.

The chance for personnel to engage with Lifelong Learning through the use of the Learning Credits scheme is seen as a core strand of the 'Thinking Skills in the Royal Navy: A Human Capability based Strategy for Education.'

For many years, the Open University (OU) with its flexible approach and world-leading blend of distance learning and innovative study materials has been an avenue for personnel to further their educational level whilst deployed.

The OU sponsor a competition for Naval Service personnel

undertaking undergraduate or postgraduate study with them. The prize rewards the considerable effort made by Naval Service personnel who voluntarily undertake a course of study with the OU.

The prizes are awarded to the students that achieve the highest Overall Examinable Score (OES) for a Level 3 (or higher) course that attracts 30 or more points.

There is no restriction on the subject that is studied.

This year's prize winners are Lt Laura Parker and CPOWTR Christopher Banks who will receive an iPad and netbook, respectively.

This is an annual competition and the 2014 competition will be advertised later this year.

*Where to look*

- GALAXIES**  
11-2014: Naval Bases return to Navy Command.  
10-2014: Government Security Classification (GSC) System Launch April 2 2014.  
09-2014: Volunteers for service in NATO Command Structure Posts.  
08-2014: Armed Forces Pay Award 2014.  
07-2014: Royal Navy/Royal Marines Welfare - Restructuring of Naval Welfare.

- DIBS**  
DIB15/14: Armed Forces Pay Award 2014.

- RNTMs**  
RNTM 058/14: Desmond Wettern RN Media Award 2014.  
RNTM 062/14: Guidance to individuals and commands on the use of social media.  
RNTM 067/14: Volunteers for service in NATO Command Structure Posts.  
RNTM 071/14: Welfare Grants

- DINS**  
2014DIN01-060: Pension benefits for members of Armed Forces and Reserve Forces Pension Schemes who marry their same-sex partner.  
2014DIN01-065: Joint Casualty and Compassionate Centre (JCCC) - New contact details and visit/briefing request processes.  
2014DIN01-068: Armed Forces Home Ownership Scheme (AFHOS)  
2014DIN01-074: Royal Navy Engineering General Service Chief Petty Officer and Petty Officer (Marine Engineering and Weapon Engineering) - Financial Retention Incentive (FRI)  
2014DIN07-055: Joint Service Sail Training - Exercise SCOTWEST 2014.  
2014DIN07-056: Joint Service Adventurous Training (JSAT) Mountain Bike Scheme.  
2014DIN07-060: Adventurous Training Service Sub-Aqua Diving: Planning Expeditions in 2015 to Ascension Island, Cyprus and Gibraltar.  
2014DIN07-061: Adventurous Training Sea Kayaking: Planning Expeditions in 2015 to Cyprus.  
2014DIN10-027: Inter-Services Cricket - Twenty20 Tournament - Lord's - June 3 2014.

## Discount at hotel

AN HOTEL in Hampshire is offering a ten per cent discount for members of the Armed Forces.

The Winchester Royal Hotel will offer the discount off all family events and celebrations.

The hotel has recently completed a substantial refurbishment programme and is located in the heart of the city.

Among its facilities are a secret garden.

For further information email [events@winchesterroyal.com](mailto:events@winchesterroyal.com) or call 01962 840840 and ask for the events manager.

**NEED to get your message across?**

To feature in the *Navy News Two-Six* pages contact Navy Command Media - Internal Comms Staff Officer:  
Lt Cdr Emma McCormick, 93832 8809, email (Dii) [NAVY.MEDIACOMMS-IC-TL@mod.uk](mailto:NAVY.MEDIACOMMS-IC-TL@mod.uk)



# Top reasons to pick Navy

## Ensure you are skilled

VICE ADMIRAL David Steel, Second Sea Lord and Chief of Navy Personnel and Training, has recently conducted visits to two of the many leisure facilities from which personnel and their families can benefit as members of the Royal Navy and Royal Marines.

The China Fleet Club in Saltash on the outskirts of Plymouth and Southwick Park Naval Recreation Centre just outside Portsmouth have much in common. Both offer significantly reduced rates for serving personnel for fantastic facilities and both still have plenty of spare capacity.

Having spent time at both locations, Vice Admiral Steel commented "In my 34 years in the Royal Navy I was not aware of some of the superb recreational opportunities available to not only our serving personnel but also their families.

"There are so many reasons to join and stay in the Royal Navy and the benefits available from Southwick Park and the China Fleet Club are excellent examples."

The China Fleet Club was originally established in Hong Kong in 1903 to benefit the serving ratings and other ranks of the Royal Navy.

The value of the land the club was on rose significantly during the 20th century and, when it was sold, raised a considerable amount of money. This money was put into a trust and was used to fund the building of the new China Fleet Club which opened in 1991 to which all non-commissioned RN & RM personnel are members by right.

The club has maintained its ethos to provide a place with a family atmosphere and first-class health and leisure facilities from which RN personnel can benefit.

It offers heavily discounted rates for its hotel rooms, gym membership, golf course, newly-built £500k luxury spa and even free function room hire for ship's company functions or individual weddings, amongst much more on a Pay-as-you-Play or subsidised monthly membership basis.

Its CEO, recently retired WO1 Alex Sharpe, said "We have much to offer Royal Navy personnel and their families, from individuals wanting to use the gym, a relaxing day for husbands and wives at the spa, an apartment for the weekend for a family break, friends from a ship wanting a game of golf together, we like to think we have something for everyone here."

Southwick Park Naval



● Above: Second Sea Lord Vice Admiral David Steel presents Southwick Park Chairman Lt Cdr Steve Toone with a 2SL plaque

Left: Vice Admiral Steel with the RN woman's golf team, staff and RN members of Southwick Park.

Below: Vice Admiral Steel with Chairman of the China Fleet Club, Rear Admiral Michael Wood



Recreation Centre was established during the 1970s through funding made available after the abolition of the rum tot to the Navy.

Its original aim was to create an establishment for the sporting and recreational use of Naval personnel and their families.

This principle is still a central

tenet for the centre and is applied through discounts and attractive membership schemes to a beautiful 18-hole golf course and one of the finest fishing lakes in the South East of England.

The centre has always been, and continues to be, run by serving members of the Royal Navy. Current Chairman, Lt Cdr

Steve Toone, sees the importance in retaining these links:

"This is a centre run by the Royal Navy for the Royal Navy with our people in mind.

"We have flexible memberships that other clubs can't offer: reserved tee times, academy sessions, team building opportunities and so much more.

"We are currently underused and I would love to see more Royal Navy personnel here making the most of what is on offer to them."

For more details ask a PTI or visit: <http://www.southwickparkgolfclub.co.uk/> and <http://www.china-fleet.co.uk/>

THE collective term used to set out the educational standards that ratings and other ranks require for promotion is called Education For Promotion.

The current qualifications which have been developed by the UK government as part of an initiative to improve the country's literacy, numeracy and ICT skills are Functional Skills.

All personnel must attain a Level 1 Functional Skills qualification in English and mathematics in order to be educationally qualified for promotion to LH/Cpl.

All personnel without Level 2 qualifications are to achieve Level 2 Functional Skills in English and mathematics prior to promotion to substantive PO/Sgt.

Functional Skills are the latest in a number of Government initiatives to raise the level of literacy and numeracy.

This has led to in excess of 25 education competences being in place to communicate the achievement of a Level 1 and/or 2 qualification.

From September 1 2014 the number of Education Competences used to support the Education For Promotion (EFP) framework will be reduced to just six.

This change will have no impact on the educational requirements for promotion to LH/Cpl or PO/Sgt.

Personnel will need to have as a minimum the competences annotated on JPA to be educationally qualified for promotion to Leading Hand/Corporal.

Subsequently, personnel will then need to have as a minimum one competence from each subject area annotated on JPA to be educationally qualified for promotion to PO/Sgt.

The migration of personnel's current JPA Education competences will be undertaken centrally by NCHQ and completed by September 1 2014.

Where an individual identifies that the competence is not annotated but it is believed that an appropriate qualification is held then the individual should contact their local Education Centre.

Requests for changes to educational status are to be submitted to NAVY TRG HQ-EL3 E1A together with certified true copies of the certificates.

The policy relating to Function Skills is fully detailed in JSP 898, Part 4, Chapter 1 and BR 3, Chapter 96, Section 3.

NAVAL FAMILIES FEDERATION 

## Super support for Service children

WITH 2014 marching on at a real pace, we thought that *Navy News* readers might like to have a neat bundle of updates on some of the areas that affect Naval families, writes Jane Williams, Deputy Chairwoman.

CEAS (Children's Education Advisory Service) has created the Moving Schools Packs to help support your child during relocation.

The pack consists of three booklets. One is a guide for parents, and contains a variety of pointers to consider and discuss when looking at a new school.

The second is a *Children's Activity Book* with some really positive suggestions for children to think about and do. The third focuses on *Schooling History* both for parents and prospective new schools.

The packs are available free to any

family in the Armed Forces. To receive a pack please contact your local HIVE.

Listings of HIVE can be found via the Royal Navy website: [www.royalnavy.mod.uk/Community/Royal-Navy-Community/HIVE](http://www.royalnavy.mod.uk/Community/Royal-Navy-Community/HIVE) or visit CEAS website: [www.gov.uk/childrens-education-advisory-service](http://www.gov.uk/childrens-education-advisory-service) and click on the Moving Schools button to download information.

Lifeworks Families now has a dedicated website, full of information, advice and details of how spouses and partners of serving military personnel (including Reservists) can get free employment advice.

Lifeworks Families aims to give military spouses and partners the tools they need to get a job; not just any job but one that is right for them, that they

will enjoy and that they will succeed in.

Follow the links via our website [www.NFF.org.uk](http://www.NFF.org.uk) to find out how the Lifeworks Families programme can help you or someone you know that needs that extra lift to get onto the employment ladder.

A guide for parents and carers who are supporting children, young people and families during periods of deployment, a new booklet designed to give information about the range of questions and scenarios that Service families face is now available.

It is designed to give tips about preparation for departure, ideas to employ if a child(ren) are upset, keeping in touch, how schools can help and coming home and settling back into a family rhythm.

Contact your local HIVE for a copy or request a copy as part of a Pre-Deployment Pack. Listings of HIVE can be found via the Royal Navy website: [www.royalnavy.mod.uk/Community/Royal-Navy-Community/HIVE](http://www.royalnavy.mod.uk/Community/Royal-Navy-Community/HIVE)

Do you live in or are you considering using Service Families Accommodation (SFA)? If so then keep your eyes peeled for announcements regarding the Next Generation Estates Contract (NGEC).

Under plans to deliver a UK-wide repairs and maintenance service, a new contract is in the process of being awarded, with an announcement date for the contract forecast as falling in either May or June 2014.

Please keep watching for announcements via [www.NFF.org.uk](http://www.NFF.org.uk) and in *Navy News* and *Homeport*

magazine.

The NFF is delighted to confirm that Nicola Thompson has joined the LIBOR-funded Armed Forces Covenant team. Nicola has the remit to engage with Service Providers in the south and south west, which compliments the ongoing work in the Midlands and north.

The new-look NFF website has a dedicated Armed Forces Covenant section; [www.NFF.org.uk](http://www.NFF.org.uk), and *Homeport* magazine also has a dedicated section to the family of covenants.

Your experiences form the basis of our discussions. To get in touch with NFF, Tel: 02392 654374. E-mail: [Admin@NFF.org.uk](mailto:Admin@NFF.org.uk) or write to: Castaway House, 311 Twyford Avenue, Portsmouth. PO2 8RN.



# 'Everyone should visit'

## Culdrose sailors 'humbled' touring Great War battlefields of the Royal Naval Division

IN A village of fewer than 80 souls in the gentle Picardy countryside, today's sailors pay their respects on one of the Royal Navy's most hallowed patches of ground.

This is the monument to sailors who fought – and died – on the Somme 98 years ago, the men of the fabled Royal Naval Division.

Nearly a century later sailors from 829 Naval Air Squadron spent a week visiting the battlefields of northern France to learn of the sacrifices made by Allied troops nearly a century ago.

The personnel normally fly and maintain a Merlin as part of 03 Flight, supporting Type 23 frigates on deployments.

But with the centenary of the Great War impending – accompanied by international commemorations – the sailors from RNAS Culdrose in Cornwall were keen to learn more.

In particular, they wanted to follow the footsteps of the Royal Naval Division, formed from surplus sailors when war began.

After inauspicious beginnings at Antwerp, the sailors-turned-soldiers fought with distinction in Gallipoli before being transferred to the Western Front in 1916, where they spent the remainder of the war.

Guided by Culdrose's health and safety advisor – and passionate Royal Naval Division historian – Aidan 'Chippy' Wood, the sailors moved south to the Somme: Flers, scene of the first tank battle, and Delville Wood, where South African soldiers suffered bloodily in the summer of 1916, and the Ancre valley, where the RND was committed in the final days of the Somme offensive.

The division lost an average of three officers and 53 men every day in November 1916 – nearly 4,000 dead and wounded by the month's end, a fact which really hit home as the 829 squadron personnel walked the battlefield.

The division stormed German positions at Beaumont sur l'Ancre – an attack which earned praise from the British Army's head, Douglas Haig, and was described as "a brilliant piece of work" by *The Times*.



Today an imposing obelisk, paid for by *Daily Mail* owner Lord Rothermere, whose son Vere was killed on the Somme, stands in memory of the sailors' deeds.

Fittingly, the Culdrose sailors held a short service of remembrance before laying a wreath at the foot of the monument.

"It was a very meaningful and sobering day," said Lt Cdr Simon Stevenson, who led the service.

"Our small ceremony was very befitting for the exploits of these 'land sailors' who retook the village."

CPO Gus Cowley added: "It was an experience I will never forget – to be fortunate enough to show our respect to fallen comrades and to lay a wreath at a relatively-unknown monument was an extremely proud moment for myself and fellow Flight members."

At every step of their tour of the Western Front, the Culdrose sailors have been struck by the sheer scale of the sacrifice 100 years ago.

"The human toll was on an almost industrial scale for the gains of a few yards. It's been very humbling," said Lt Cdr Stevenson.

His sentiments were echoed by WO2 Stuart Nanson, the Flight's senior engineer.

"The sheer number of deaths in this small area was more than could

ever have been expected," he said. "Reading the personalised messages on gravestones from families of the soldiers was a very emotional and humbling experience."

### GREAT SACRIFICE

#### DEEDS TO OUTLIVE US

#### HELL OF PASSCHENDAEL

On the Western Front, there is no more sacred corner of a foreign field which is forever England (and, lest we forget Scotland, Ireland, Wales and the Commonwealth of nations), than Tyne Cot – the largest Commonwealth War Graves Cemetery in the world.

Some 12,000 souls, many of them unknown, are buried there, victims of the battle which sucked the soul out of the British Army in the Great War: Passchendaele.

Not a few of the men laid to eternal rest in its grounds are sailors, who fought in the RND in the final stages of the Passchendaele offensive, and suffered more than 1,400 casualties – dead, wounded and missing.

One of the signal successes of the sailors in 1917 was the capture



● The impressive but haunting sight of the thousands of graves at Tyne Cot Cemetery in Flanders, just one and half miles from where the Royal Naval Division fought at Passchendaele in October and November 1917

of Varlet Farm – turned into a stronghold by the Germans – and stormed by the Hood Battalion.

After the war it was rebuilt and now acts as both a working farm and guest house for people paying homage to the men of WW1.

"The farm was captured and successfully held by a group of 11 sailors led by Sub Lt Stevenson – which the Flight found extremely impressive as the group visiting the farm was also 11 people," said PO Ian Sibley.

"To have to successfully defend the farm against a German offensive with just 11 sailors is a massive achievement."

Every bit as moving as Varlet Farm and Tyne Cot was the visit to the Menin Gate in Ypres, a memorial to the unknown dead, and the tunnels of Arras, dug by miners from New Zealand, ahead of the battle in which the RND fought in the spring of 1917.

The sailors captured the village of Gavrelle for the cost of 192 lives, a feat marked by a striking memorial which features an anchor in the middle of the Belgian countryside.

In all, some 50,000 men served with the Royal Naval Division during the war. One man in every five was killed.

Despite such losses, the sailor-soldiers – who were

true to their naval roots, keeping naval ranks, insignia and language – were regarded as some of the elite troops in the British Army by the war's end.



● The plaque erected at the rebuilt farm in honour of the sailors who captured the ruins of the original building in October 1917

Having completed their WW1 pilgrimage, every man in the Flight is convinced that all should visit the Western Front for a greater understanding of the sacrifices made by the RN – and the nation – 100 years ago.

"The week completely shattered my preconceptions of World War 1," said CPO Cowley.

"The enormity of the death and destruction is truly breath taking. What I will take away is that throughout it all, the British soldier remained upbeat and looked after

their own. Everyone should visit one of these memorials."

PO Sibley added: "The scale of war and amount of brave and courageous men that lost their lives is truly staggering. Their dedication and attitude will never be forgotten. I feel I now at least understand enough about WW1 as before I knew very little, if not anything at all. A very enjoyable week that really has opened my eyes to the war and a week that I could not help but be moved by."

And from LAC Nick Hooper: "Two things stood out for me: the number of unknown graves in the cemeteries – each a person with their own story left unfinished and a family left in mourning."

"The second is having seen the pictures of towns completely decimated by war – it really brought home the scale of destruction that the region suffered. It was a hugely eye-opening and harrowing week."

■ You can read more about the RND's deeds in our commemorative WW1 supplements. Somme 1916:

<http://content.yudu.com/Library/A21hcu/200611NavyNewsNov06/resources/41.htm>; Gavrelle and Arras at <http://publishing.yudu.com/A9cr/navynewsapril/resources/25.htm>; and for Passchendaele [publishing.yudu.com/A2txg/navynewsoct07/resources/45.htm](http://publishing.yudu.com/A2txg/navynewsoct07/resources/45.htm).

**SUBSCRIBE NOW! 12 ISSUES FOR THE PRICE OF 10\***

**From just £28.00!**

\* UK 1 Year only

- Keep up to date with all the latest news from around the world
- Subscribe today and get 12 issues for the price of 10



Please note, cheques payable to 'HMG1800' and not 'Navy News'

YES, I would like to subscribe to Navy News

(please refer to the table opposite for prices)

Send the completed form and payment to:

**Subscriptions,**  
Navy News, HMS Nelson,  
Queen Street, Portsmouth  
Hampshire PO1 3HH, England  
Tel: +44 023 9272 6284 (24hr answerphone)  
Fax: +44 023 9273 4448  
email: [subscriptions@navynews.co.uk](mailto:subscriptions@navynews.co.uk)

#### 1. COMPLETE YOUR DETAILS

Name \_\_\_\_\_  
Address \_\_\_\_\_  
Postcode \_\_\_\_\_  
Country \_\_\_\_\_  
Phone Number \_\_\_\_\_  
Email \_\_\_\_\_

#### 2. CHOOSE YOUR SUBSCRIPTION

05/14

Region	Years	Rate	Tick
UK	One	£28.00	<input type="checkbox"/>
UK	Two	£56.00	<input type="checkbox"/>
UK	Three	£84.00	<input type="checkbox"/>
Overseas	One	£36.00	<input type="checkbox"/>
Overseas	Two	£72.00	<input type="checkbox"/>
Overseas	Three	£108.00	<input type="checkbox"/>

#### 3. COMPLETE YOUR PAYMENT DETAILS

I enclose

Cheque  Postal Order  IMO

in £ Sterling made payable to 'HMG1800'

I wish to pay by

Visa  Mastercard  Delta  Switch/Solo

Payment Amount £ \_\_\_\_\_

Card Number \_\_\_\_\_

Start Date \_\_\_\_\_ Expiry Date \_\_\_\_\_ Issue No. \_\_\_\_\_ CSC No. \_\_\_\_\_

Signature \_\_\_\_\_ Date \_\_\_\_\_

This is a

New subscription  Renewed subscription

Start my subscription from month \_\_\_\_\_



# Another twist in the Bismarck tale

## WHO sank the Bismarck?

A question asked – and answered – many times since the pride of the Kriegsmarine was sent to the bottom of the Atlantic on the morning of May 27 1941.

Maybe it was the guns of the Home Fleet. Or the torpedoes of the Dorsetshire. Or perhaps the Bismarck was scuttled.

That any of these ends came to pass is down to a strike the previous evening by Swordfish from HMS Ark Royal – and a torpedo hit which disabled the battleship's rudder.

And who delivered that disabling blow has also been argued over by historians.

A few years ago Jock Moffat's memoirs were published as *I Sank the Bismarck* (a title which the wonderfully-modest nonagenarian really didn't care for).

And like most historians delving into the Bismarck story, Iain Ballantyne believed Jock was the last surviving Swordfish crewman when researching *Killing the Bismarck* (which we favourably reviewed in our October 2010 edition).

He isn't. For the paperback version of book (*Pen and Sword*, £14.99 ISBN 978-1783-

462650), the author has tracked down Canadian Cdr Terry Goddard, a former observer in 818 NAS – and a survivor of that attack.

Now 94, the veteran aviator provides a vivid account of the few days Ark Royal spent hunting down the German battleship – Goddard calls the episode 'the Bismarck fiasco'.

He paints the impression of a small breed of very keen fliers, eager to get at the foe – whatever the weather – and some surprisingly indifferent officers on Ark Royal seemingly averse to risking all by launching Swordfish strikes in bad weather, and not especially interested in their exploits when the aircrews returned from not one, but two sorties against the Bismarck.

And for all those who dismiss the Swordfish as a relic of a bygone age (the Germans certainly did), Cdr Goddard offers a stirring defence.

It could land and take off in almost any weather, was surprisingly manoeuvrable, even in a dogfight with a Messerschmitt 109, and was considered by crews to be "a lucky aircraft".

The sight of Bismarck on



● Sixteen Swordfish are lined up on Ark Royal's flight deck ahead of a sortie

the evening of May 26 was, says Goddard, "mesmerising". His pre-attack fears vanished, replaced by elation, anger, or maybe even a gung-ho attitude. The torpedo dropped by

Goddard's pilot Stan Keane hit the Bismarck – but it wasn't the fateful blow on the rudder; it struck port side, forward of the bridge.

So who did knock out Hitler's

flagship? Well, Terry Goddard is adamant that none of 818 NAS' 'A Flight' scored a single hit – and that rules out Jock Moffat's aircraft.

More likely are Ken Pattison or David Godfrey-Faussett (the latter treated himself to a cigar on the two-and-a-half-hour flight back to the Ark), probably Pattison.

Whoever scored the vital hit – and Terry Goddard is keen for the matter to rest – all were brave and skilful young men, and men of compassion and humility.

On May 27 the Swordfish were launched again to deal Bismarck another blow. They found their work already done by the Home Fleet, their German opponent "a pathetic hulk".

Goddard writes: "The sea surrounding Bismarck was filling up with bobbing bodies. Staring down in horror I saw the carnage continue: salvo after salvo hitting Bismarck and claiming survivors in the sea around her.

"Of course, Bismarck had to be

sunk and the Hood avenged. This was brutal, not at all pleasant to watch. Savage revenge? Or was it the RN's surprised guilt that the cancellation of three Hood refits

had left the battle-

cruiser vulnerable?"

Terry Goddard's memoirs are by far the most important addition to this paperback version. Other accounts help to add more colour to the terrible battle and chase in the North Atlantic in late May 1941 – and underline the humility of the British sailor. However shocking the loss of Hood was, he

was not out for vengeance. Even without the extra information, *Killing the Bismarck* remains the definitive account of the British part in the battle (gunnery officer Burkard Müllenheim-Rechberg has provided the definitive view from the German side in *Battleship Bismarck*).

Add the two together, and you have the complete Bismarck story. But they won't be the last word.



# For flak get HACS

WITH **Naval Anti-Aircraft Guns and Gunnery** (£45 ISBN 978-184-832-1779) Seaforth and Norman Friedman have produced another monumental contribution to the technical history of 20th-Century naval warfare.

This complements their study of surface gunnery and covers anti-aircraft gunnery and its related fire-control systems.

As usual, the study is a comprehensive analysis of how technology related to policy and doctrine and reflects a massive amount of research in British and American archives, writes Prof Eric Grove of Liverpool Hope University.

In this case, there is also an excellent additional chapter on 'the evolving threat' of aircraft that could not be bettered as an informed summary of the subject. The main text is accompanied by some excellent illustrations whose extended captions form a book in themselves. Finally there are 68 pages of notes which, in typical Friedman manner, are both source notes and significant additions to the overall account. All this makes reviewing the book a significant challenge, but it is a most rewarding one.

The author provides perhaps a definitive analysis of the much-criticised British High Angle Control System (HACS) developed in the inter-war period – and so denounced by gunnery officer Capt Stephen Roskill in his classic histories. These were countered by some interesting oral evidence I obtained some time ago from a not-entirely-disinterested Admiralty scientist, so I looked forward very much to the Friedman analysis which I knew would be balanced, given Dr Friedman's positive attitude to the Royal Navy as displayed in his earlier works. He would not take an American nationalist view of British developments.

Friedman explains clearly how the Admiralty tried to develop a fully tachymetric system – namely one that measured the motion of the target. Unfortunately, tests in the mid 1920s demonstrated that it was impossible to gyro stabilise the shipboard sights given available technology.

Instead the system adopted was based on estimates of the target's course and speed. The adoption of such a system reflected the British doctrine that gunnery was an interaction between technology and, as Lord Chatfield put it, "the skilled user of weapons"; in Dr Friedman's words, the "Royal Navy distrusted mechanical solutions to gunnery problems."

The system was designed to deal with high-level bombers, not diving or climbing targets and its weaknesses even in this role were clear in pre-war trials. This was made up for, to some extent, by the recognition of the importance of barrage fire and light automatic guns with which, as Dr Friedman points out, the Royal Navy was uniquely well equipped at the outbreak of war compared to other major navies. The multiple 2 pdr 'pom

## THE GROVE REVIEW

pom' in quadruple and octuple mountings was a good weapon for its time. These became even more effective when equipped with tachymetric sights at the outbreak of war.

When the light cruiser HMS Delhi was rearmed under Lend Lease in 1941 as a US destroyer, it was fitted with the tachymetric Mk57 fire control system which (contrary to my oral evidence) greatly impressed the British. Only the need of equipment for America's own war programme prevented more such conversions, although Mk57 systems were supplied for new British construction.

Interestingly, however – and possibly of the origin of my misleading oral testimony – in 1945 a heavily-modified HACS 4 system using a 'Gyro Rate Unit Deflection Oil Unit' produced better results than Delhi had against a sleeve target. Such a combination only went to sea with the carrier Implacable in 1945.

Nevertheless "Mk37 was considered much better at long and medium range." Even the arrival of proximity fused (Variable Time – VT) fuses did not solve the problem. The system could not get the shells close enough! I think the case against HACS is closed.

Where the British led our allies however, was in the organisation of AA defence. World War 1 experience had demonstrated the importance of target indication, the designation of targets for engagement by AA systems. In the 1930s, the concept of the Air Defence Officer was developed to make the choice.

During the war the Americans realised the importance of target indication, but it was only introduced into US practice after the war. Where the Americans had the advantage was that their longer range systems were accurate enough to be integrated very successfully with VT fuses and their ships, unlike the Royal Navy's, had sufficient design margin to have their light AA armaments more easily enhanced.

Both the Germans and Japanese had weaknesses in their air defences, decisive ones. Dr Friedman confirms that the German 37mm gun was hand loaded, greatly restricting its rate of fire to 30 round per minute. The author suggests this was a result of the Versailles Treaty which prohibited machine-gun development.

Only in 1944 were rapid-firing Bofors-type guns adopted. This accounts for the poor performance of these weapons in defending Bismarck from Swordfish biplanes. The latter were also helped by the high likelihood, now confirmed and fully explained by Dr Friedman, that the fire control system for the main 4.1 in AA armament found it hard to cope with slow-moving targets.

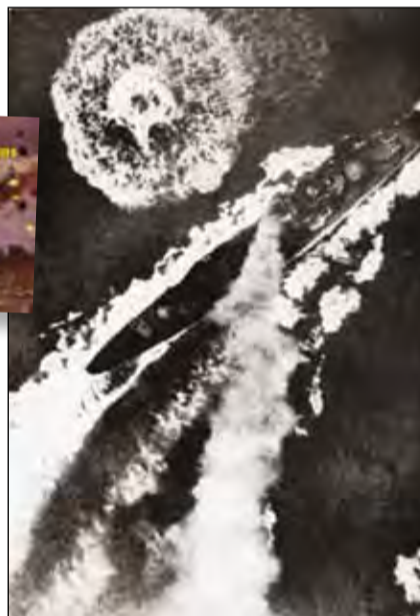

● A near miss for HMS Gloucester as she runs the Luftwaffe gauntlet off Crete in May 1941. The Fighting G eventually succumbed to the air attacks

Japan was even worse off. They had no guns in the 40mm category and the 25mm Hotchkiss-type weapon adopted and deployed in large numbers was deficient in operational rate of fire and weight of shell. I was a little surprised that the author did not make this point as strongly as he might have done. It is interesting, as the author points out, that the Japanese adopted manoeuvre as a main means of AA defence – despite the difficulties posed to their own AA defences. The author provides an excellent description of the sinking of the super battleship Musashi which, despite using its massive 18.1in guns in barrage fire against its aerial assailants, was repeatedly torpedoed and sunk. He also makes interesting comparisons between this action and the sinking of her sister Yamato.

Although World War 2 provides the core of the book, it also covers the post-war period as it affects AA gunnery and, albeit briefly, Dutch, French and Italian developments.

Overall it is a magnificent volume, which no serious student of naval warfare should be without. It would have gained from a little more editing in places and perhaps greater integration of the notes with the text but these are quibbles.

No-one can read it without greatly improving their knowledge. Given its combination of content and production, it is good value. It can, however, be obtained at a very substantial discount on the Internet. There is therefore no excuse for not acquiring it.

# To hell and back in Iraq

IN THE past 100 years, Allied forces have thrice tried to take Baghdad.

In 2003, after a month's fighting, they succeeded. As they did in the spring of 1917.

In 1915, they got as far as the ancient ruins of Ctesiphon – just 18 miles from the heart of what was then Mesopotamia.

And there, over four days, the Imperial forces were beaten, losing nearly half their number. They fell back along the Tigris, dug in at the town of Kut, were promptly encircled and forced to surrender after a four-month siege.

A Royal Navy flotilla accompanied the force almost as far as Ctesiphon, including Ordinary Seaman Phillip Gunn, one of the battle's 4,600 casualties.

His story is told by his son David in *Sailor in the Desert: The Adventures of Phillip Gunn DSM RN in the Mesopotamia Campaign 1915* (*Pen and Sword*, £19.99 ISBN 978-1783-462308).

Gunn was serving in the paddle yacht HMS Comet, supporting the British push up the Tigris. As the advance continued, he was transferred to a former police launch towing a couple of barges armed with 4.7in guns (thought to have last been fired during the Boer War). To spot for the guns, an Army officer clambered up a ladder precariously rigged into place by Gunn.

It sounds comical – were it not for the life and death nature of the campaign.

Outside Kut, 100 miles from Baghdad, Ottoman forces were routed at the end of September 1915, leaving the battlefield littered with the dead of both sides. The area's native population viewed both sides as invaders – and treated the dead accordingly, stealing clothes, possessions, ripping gold teeth out. Some, Gunn says, gouged out the eyes of the living. Three Arabs were caught by Britons carrying out such mutilation. Justice was quick and brutal. "They swiftly erected a gallows, hanged them and left them to swing in the night air."

At Ctesiphon, in the heat of battle, Phillip Gunn collapsed through malaria – which actually saved his life, for his gunboat was later sunk with the loss of all aboard.

Mosquitoes had plagued the drive on Baghdad – and medical facilities were overwhelmed ('ambulances' at Ctesiphon comprised ox carts, while Gunn overheard one medic complain: "I'd like to know who was responsible for this shambles").

Gunn spent several days in and out of consciousness as he was transported down the Tigris by cart and paddle steamers – Gunn's descriptions of the latter with its lack of water, food and hygiene are particularly grim.

Indeed, it's perhaps a miracle that he survived; he eventually reached the rank of captain, advising Churchill in the run-up to D-Day. Upon leaving the Service, he became a landscape artist – and many of his colourful paintings are used to illustrate this very lively account of an oft-forgotten naval campaign.

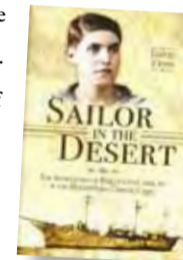



**WARSHIPS**  
INTERNATIONAL FLEET REVIEW

Available in all good Newsagents our monthly magazine is packed full of naval news and articles from around the globe.

**COMING in June 2014 - Guide to the Royal Navy - our ever popular Special Issue!**

2014 Issue On Sale June 6th 2014

HPC Publishing, Drury Lane, St Leonards-on-Sea, East Sussex, TN38 9BJ, UK  
T: 01424 723167 E: subs@hpcpublishing.com



## CO is dined out in style

LOUGHBOROUGH unit, in true Naval tradition, dined out Lt (SCC) Kay Adey RNR after 11 years in command of TS Venomous.

The night was attended by former cadets – some serving and some ex-RN in uniform, staff old and new – from units around Northants and Leics District, friends and supporters of the unit and the unit committee.

Also there were members of Loughborough ATC 2229 Sqn, who have developed a close relationship with the unit, and who presented Lt Adey with a bottle of Champagne to wish her ‘clear skies’ in the future.

Lt Adey was presented with flowers and an anchor-mounted clock, which her successor CPO (SCC) Ray Adey pointed out would be “just right for the wardroom when the unit was rebuilt...”

Lt Adey reflected on many aspects of her time in command that were unexpected, from initially taking command to the fire (arson) which destroyed the unit in 2012 – and the fact that she was possibly the only CO to hand over a unit without a building.

She paid tribute to the many young people who had made her time in the job a ‘true joy’ and those who had given her grey hair.

Lt Adey also paid tribute to the loyalty of the staff who have supported her over the years.

Although leaving Loughborough for a while, to serve at Leicester unit as 1st Lt, Lt Adey will eventually return – and may even take the clock to the wardroom.

## Double success

WARSASH unit’s success in district drill and piping competitions continued in a cavernous former aircraft hangar at Thorney Island.

Competing against 32 other teams in the Wessex district from as far afield as Poole and Worthing, the Warsash team had some hard work ahead of them.

But they went home with plenty of silverware.

The junior section put their name on the trophy for the fifth year running.

And their senior colleagues stepped up to the mark as well, winning their section for the first time in their unit’s history – and prising the trophy out of the hands of near-neighbours Southampton, who had held the title for 15 years.

Both teams qualified for the Southern Area finals in Aylesbury.

## Southampton team tidy river foreshore



SOUTHAMPTON unit members donned boots and gloves to clear flotsam and jetsam (and a fair bit of rubbish) from the foreshore at Bitterne Manor Park.

Cadets, staff and supporters (left) cleared the river foreshore of cans, bottles, bricks and any other rubbish they found – filling a whole skip, to improve the area.

“It has been a real challenge for the cadets,” said CO Lt (SCC) Mark Lampert RNR. “After the recent bad weather, we were kept busy, but they don’t mind getting dirty and they want to help keep the foreshore clean for their neighbours.”

Helping their neighbouring community is part of an agreement with the City Council and Natural England, which will enable the Sea Cadets improve their own facilities at their headquarters in Vespasian Road.

## Units pay tribute to Keith

STAFF and cadets of Loughborough unit, along with sister unit Leicester North, are mourning the death of PO (SCC) Keith Padgett at the age of 26.

Keith battled with a genetic illness for some time and died peacefully, surrounded by family and friends, on April 2.

He joined the Corps as a cadet in September 2000, and by 2004 had become a leading hand.

Keith had a great love of anything waterborne and was never happier than when he was out in a boat of some description, and colleagues remember that he had the knack of making everything fun and, as a cadet, volunteered for everything.

In 2006 he joined the staff at Loughborough as a trainee instructor, becoming a full PO in 2009, by which time he held qualifications in kayaking, rowing, sailing and power boating.

In 2011 his work took him south and he transferred to Trowbridge unit, but returned to Loughborough in 2012.

Keith then went on to gain qualifications in navigation, VHF radio, CIS and First Aid.

Over the past year Keith had been in and out of hospital, but attended the unit at every opportunity.

OiC Loughborough unit CPO(SCC) Ray Adey said: “It is not only the current staff and cadets who feel Keith’s loss – we have received many messages to pass on to his family from ex-cadets, staff and people Keith met through his time in the Corps.

“His love of, and dedication to the Corps was wonderful and we were privileged to have known such a courageous young man.

“Our thoughts and prayers are with his mum, Ruth, who also volunteers with us, his sister Helen and his grandparents.

“We count them all as part of our Sea Cadet family.”

# Cruise lines weigh in with appeal donation

A CRUISE industry giant has weighed in to help the New Ship Appeal with both a hefty donation and a promise of ongoing support.

Carnival Corporation, the parent company of Southampton-based P&O Cruises and Cunard, has donated £380,000 towards the cost of the Sea Cadets Corps’ new flagship.

The cruise lines will also support the seamanship qualification which will enable 14,000 Sea Cadets between the ages of ten and 18 to broaden their career options in the maritime industry.

The badge will enhance the Sea Cadet experience by offering young people the chance to explore all types of maritime career, helping to give them the best possible head start in life.

Captain Sea Cadets Capt Jonathan Holloway said: “Sea Cadets know about opportunities in the Royal Navy, but this is a fantastic opportunity for them to explore a career in a commercial maritime industry or working directly for a cruise company.

“It opens up opportunities they didn’t know existed.

“Carnival is not just donating money towards our new flagship, but by sponsoring our seamanship



● Cadets from Southampton unit with Captain David Pembridge on the bridge of Carnival cruise liner Azura.

qualification and offering ship visits they are helping young people build their careers.

“We hope that our cadets will grab this opportunity with both hands.”

Carnival UK Chief Executive Officer David Dingle said:

“Sea Cadets provides a solid foundation for youngsters.

“It teaches them practical and life skills which will stay with them throughout their journey into adulthood.

“These young people are our future and we should take every

opportunity to invest in them and in their chances to learn and grow.

“I am delighted that we are able to play a part in this with our donation to their new flagship and seamanship qualification.”

Sea Cadets who complete their seamanship qualification may have an opportunity to visit P&O Cruises or Cunard ships in port, and some will be invited to a certificate ceremony hosted by the cruise lines.

Across the UK young people will gain a seamanship qualification with Sea Cadets by learning a range of skills essential to operating in the maritime environment.

This qualification is the foundation of a career at sea and any water-based activity, plus the qualification will enhance cadets’ experience on the new flagship that Carnival has helped fund.

Whether at sea or on land, Sea Cadets offers young people between 10 and 18 an environment where they can find new confidence and inspiration, through nautical adventure.

Across the UK 14,000 young people are challenging themselves and learning new skills based on the customs and traditions of the Royal Navy to give them the best possible head start in life.

## Northampton salutes victims of HMS Laforey

THE town of Northampton raised more than £750,000 during World War 2 for its adopted warship, HMS Laforey – the equivalent of well over £18m today.

Laforey was launched in 1941 and commanded by Captain D, Capt Hutton, who had four destroyers under his command.

The town even sent fur-lined boots for the ship’s company, who suspected that the town knew something of proposed service on the Arctic convoys.

However, the ship saw all of her active service in the Mediterranean.

Laforey was one of the largest destroyers in the fleet, and having had only 12 days to work up before entering active service she used her 4.7in guns in support of Allied landings in Italy.

She was involved in protecting Malta convoys and was a U-boat hunter.

Under the command of Capt Armstrong, who took over from Capt Hutton just months earlier, she detected U-223 on March 30 1944.

After a long chase she forced the U-boat to the surface, but the German warship let off one last

torpedo, which struck Laforey; the ship quickly sunk under her 258 crew, with only 69 surviving.

That year the mayor of Northampton laid a wreath at the plaque displayed in the Guildhall, and every year since a parade has been held to remember that sacrifice, organised and attended by Northampton unit cadets who proudly wear the name TS Laforey on their cap tally.

This year being the 70th anniversary was no exception, with Capt Hutton, the son of the first CO of HMS Laforey, taking the salute.

The parade was also attended by an ex-shipmate of Laforey, PO Neville Jones.

More than 150 cadets, from units across Northamptonshire and Leicestershire, escorted the unit Colour with a Guard of Honour.

The parade paused on route to lay wreaths at the Guildhall before marching on – a fitting memorial to the ship’s company and a celebration of the efforts and high standards of commitment in evidence in local young people and the current ship’s company of TS Laforey.



## TS Gallant cadets pay tribute

ON January 10 1941, HMS Gallant, part of a Malta convoy, hit an Italian mine with the loss of 59 men – though others subsequently died of their injuries.

The ship limped into Malta and, while being assessed, was bombed and deemed beyond repair.

She was subsequently towed off St Paul’s Isles and sunk as a deterrent to enemy submarines.

More than 70 years later Westerham unit – whose training ship is TS Gallant – paid their respects to the last survivor of that ship as he joined his shipmates.

That day was one of great pride and sadness as cadets and staff who had got to know PO Stoker Cyril Edwards said their goodbyes.

It was during the service that it was mentioned he had never returned to Malta, though he had always wanted to pay his respects to his shipmates, and one of the cadets asked ‘why can’t we do it for him?’

work, raising money at every opportunity, and during the year, cadets managed to raise just over £10,000 to make the trip possible.

So during half term in February this year, they were off – all the hard work had made an ex-Navy PO’s dream a reality.

A memorial service was held in Valletta, led by district padre Douglas Perkins, where wreaths were laid, a two-minute silence observed and all the names read out by the cadets.

The day was rounded off by a boat trip, though they were unable to go out to the islands, instead throwing 59 poppies into the sea.

HMS Daring was also in Malta, so along with Maltese cadets and Royal Marines they toured the destroyer (pictured above).

They also visited Mdina, and managed to fit in some shopping in Bugibba and Valletta.

**SUPPORT YOUR SEA CADETS**  
 Volunteer, donate or even leave a legacy  
 Visit sea-cadets.org or call 020 7654 7000

SEA CADETS

A charity registered in England and Wales 319013 and in Scotland SC037808



## Naval parade at Rushden

RUSHDEN unit was dressed to impress at their first Royal Navy Parade, held at the Victoria Road Drill Hall.

Inspecting Officer Cdr Charles Bagot-Jewitt was highly impressed with the standard of drill and the cadets' overall presentation.

In line with tradition the night started with Naval Divisions, during which the inspecting officer stopped and spoke to each cadet.

After Divisions there was a break for tea and biscuits before the cadets showed off their skills with displays of seamanship, first aid and Outward Bound-type activities, including a sailing dinghy demonstration.

Guests included Col Blomfield, Lt Cdr (SCC) Chris Read RNR and the town Mayor Cllr David Jenney – who is also the unit chairman.

The evening ended with the CO thanking staff and parents/guardians for all their help in making the unit so successful and for their future support in moving the unit towards full independence.

## Ports visit in France

CADETS from Southwark unit paid a visit to northern France in March to take a look at the strategically important ports of Dunkirk and Calais.

The trip formed part of the 'Spirit of Dunkirk' Project, which supplemented the military and maritime history that cadets learn as part of their training.

Accompanied by adult volunteers, the group took the Channel Tunnel to France.

In Dunkirk, they visited the Commonwealth War Graves Commission Memorial in the Town Cemetery.

The trip also included visits to maritime attractions of the Port Museum and the Belfry, as well as the Malo-les-Bains beach, from which more than 300,000 Allied troops were evacuated during the Operation Dynamo retreat in 1940.

In Calais, the cadets visited Parc St Pierre, where the local War Museum is located, and went up the 53m tall Calais Lighthouse, an important maritime aid to navigation.

Leaders of the expedition said it was an enjoyable educational experience for the group of young people, and Southwark unit would like to thank Team London Bridge for their generous support in making this visit possible.

## Bradford first

MARCUS Leadbeater has become the first Royal Marine Cadet Detachment Sergeant at Bradford unit following a period of training and assessment within the unit and at Crowborough training estate in East Sussex where he took the RMCD National Cadet Sergeants' Exam.

Bradford's detachment was formed in 2011 with Marcus, 16, one of the early members. Marcus intends to join the Royal Marines and is currently going through the assessment process.

## Suffolk honour

LC JACK Thompson of Beccles unit has been nominated as the Lord Lieutenant's Cadet for Suffolk for this year.

Jack travelled to Ipswich to be presented with his award by the Lord Lieutenant, Lord Tollemarche.



● The six Navy Board cadets line up along a section of the keel for the new Sea Cadet Corps flagship, which is currently in build in the Astilleros Gondan Shipyard in northern Spain

# Keel is laid for new sail training flagship

SEA Cadets across the UK are one step closer to realising their dreams of a 21st century UK flagship as they celebrate the first stage in the build process – the laying of the

keel of their new £4.8m sail training ship.

On Thursday April 10 at a northern Spanish shipyard in Asturias, six Navy Board cadets – each representing an area of the UK – the Commanding

Officer of the current flagship TS Royalist, and Captain Sea Cadets, Capt Jonathan Holloway, witnessed the first journey in this ship's new life at the traditional keel-laying ceremony.

Also there were trustees and chairman Capt Nigel Palmer plus the senior team from the shipyard and Acubens, the architects.

Laying the keel is the formal recognition of the start of the ship's construction, and one of four major events celebrated in the life of a ship – keel laying, launching, commissioning and decommissioning.

The keel-laying traditionally saw the initial placement of the central timber that forms the backbone of the vessel – the keel.

Today a metal keel module is more common in larger ships than a wooden keel.

Following introductory speeches the keel was lowered into position by crane.

The visitors were amazed at the size of the keel, giving a good indication of the size of the vessel to follow.

There followed a short ceremony comprising the Sea Cadet prayer, read by POC Fiona Tait, a speech by LC Craig Symmons and then, after piping, the Navy Board Cadets unveiled the keel.

One of the cadets then laid a 2014 coin within the keel for good luck.

Capt Holloway said: "This is an historic moment and much waited for."

"We are thrilled to see the start of this process, and look forward

with anticipation to the delivery of our new ship in April 2015."

A flagship voyage is the pinnacle of the Sea Cadet experience, and one from which the charity wants to ensure future generations of Sea Cadets can benefit.

The current ship, TS Royalist, is more than 40 years old and increasingly expensive to run.

The Corps' parent charity, Marine Society Sea cadets (MSSC), spent two years fundraising £4.8m to build the new ship, so far achieving £4.45m of that target.

The new ship will be ready for the 2015 sailing season and is yet to be named.

TS Royalist was originally named in honour of the Princess Royal – Princess Anne – who named the ship in 1971.

Royalist has taken more than 30,000 young people to sea since then.

The new ship, designed as a brig, will be in service for the next 40 years, ensuring that young people can continue to enjoy sailing opportunities through which they can learn valuable life skills, pulling together as a team to circumnavigate Britain's coastal waters, as well as practical sailing and navigational skills.

The innovative new ship design, created by Spanish yard Astilleros Gondan, offers greater use of space, with better all-round sailing ability and performance.

Faster and easier to handle than Royalist, the new ship will also be more economical to run.



Picture: Keith Woodland (HMS Collingwood)

## Learning the ropes

ST BARTHOLOMEW'S CCF experienced a taste of Royal Navy life when they visited HMS Collingwood for the day.

A group of 45 cadets from the Newbury-based unit, accompanied by teachers and instructors, took part in training activities which would be familiar to Navy personnel at the Phase 2 training establishment.

The cadets were split into groups and visited sections around the base, including the RN Leadership Academy.

Cadets took part in exercises on the low ropes course, encouraging teamwork and

leadership skills coupled with improving their communication skills (above).

The visitors tested their skills in the Dismounted Close Combat Trainer, an indoor electronic range, using a more powerful Naval equivalent to the .22 rifle the cadets are used to handling.

Cadet Suzy Winsor said of the low ropes: "It's been great – our coach was enthusiastic and got us involved from the start."

"He had us all engaged from the warm ups. We were all interacting well and our group went from strength to strength during the challenges."

## Students back ship's charity

Newcastle-under-Lyme School CCF Royal Naval Section cadets have been busy raising money for a charity nominated by their affiliated Royal Navy ship.

The Staffordshire students have a link with the Navy's sole deep ocean survey ship HMS Scott.

Events took place during the cadets' Friday Parade Nights, and these included sponsored canoeing in the school pool, rowing in the fitness centre and dinghy rigging.

A total of £680 was raised for the Centipede Trust which

supports babies and young children born with developmental difficulties.

In March the Section attended the Annual CCF Hydrographic Warfare Weekend at HMS Raleigh, near Plymouth.

At the final parade a cheque for the money raised was presented by senior cadets to Cdr Pat Mowatt, the Commanding Officer of HMS Scott.

Newcastle-under-Lyme School CCF has been affiliated to Scott since the ship's commissioning, and there is regular contact between the school and the ship's company.



● Tony Huntington before...



● ... and after the shave

Pictures: David Abbott

## Manager at TSB supports TS Bee

A MANAGER from the TSB has shaved off his beard to help TS Bee...

Tony Huntington, manager at TSB's Whitehaven branch, shaved off his beard to help raise funds for Whitehaven unit.

When he heard of the damage caused to the cadets' headquarters during storms in December, Tony – himself a former member of Maryport unit – felt that he wanted to do something.

"I had some fantastic times as a Sea Cadet – it was a great experience, very enjoyable and rewarding – and I just wanted to help," said Tony.

"I thought I could try to get sponsored to shave off my beard."

"The response so far has been very good – everyone has said how well respected the Sea Cadets are, which is good to hear."

"It would be wonderful if I could reach, or even beat, my target of £500."

The shave became something of a local event, with the Mayor of Copeland, Cllr Geoff Garrity, and Mayoress Sandra Garrity there to make the first 'cut' before Danyell and Penny from James Street Barbers finished the job.

And Tony has so far managed to raise more than £800, with more cash still rolling in – helped by the TSB's offer to match donations up to £500.

Whitehaven unit chairman David Abbott said that he was very grateful to Tony and his sponsors for supporting the unit.

## Grand finals

SEA Cadets from across the UK have been taking part in district and area drill and piping competitions to reach the finals at HMS Raleigh on Saturday May 3.

Throughout the day cadets will be assessed on their drill, and awarded points on their smartness of uniform, and co-ordination and team work of their march.

Individual cadets will be assessed on their piping calls, and will be awarded points on the skill and accuracy of their performance.

The winners will be announced in the next issue of Navy News.





● Lt Cdr Moira Wilcockson

## Couple ready for fight

A PORTSMOUTH-BASED married couple of medical Naval Reserve officers have more than proved themselves ready and willing for a fight.

The couple represented the RN's Amateur Boxing Association by officiating at the prestigious Royal Marines Corps' Annual Boxing Championship.

Having recently qualified as a Class A judge in the England Amateur Boxing Association, Lt Cdr Moira Wilcockson, 51, officiated at the Royal Marines' most keenly fought Corps challenge, staged in the Commando Training Centre Lympstone.

Moira is the first female reservist in the Naval Service to qualify as a class A judge in this male-dominated sport, taking up the challenge of scoring points in the boxing matches after accompanying her husband, Surg Cdr Alastair Wilcockson, 52, to numerous Forces' championships.

Alastair is one of the Senior Medical Advisors to the RN Amateur Boxing Association.

After the thrilling event, Moira said: "In previous Navy boxing matches the competitions have included both men and women but this Corps championship is very much a man's world. It can be a little daunting at first but I quickly absorbed myself in scoring the boxing, shutting out the tremendous roar of the crowds."

"I have never boxed myself but I really do enjoy watching the sport – it takes a great deal of stamina and courage to get into a ring and fight, especially for the first time."

Both Moira and Alastair are Naval reservists in the Medical Branch of the RNR, supporting training across all reservist units in the country while also being available to serve nationally when tasked by Defence Medical Services.

Alastair is the specialist training officer of the Medical Branch reservists at HMS King Alfred while Moira manages her dual roles at the Portsmouth-based training establishment, primarily as a practice nurse for the medical centre at HMS Excellent.



● Surg Cdr Alastair Wilcockson

# Debut defeat for new carrier's team

HMS QUEEN Elizabeth's football team took to the field for the aircraft carrier's first-ever competitive match against the Royal Marines Band, based at MOD Caledonia.

The fixture took place adjacent to the Rosyth base and despite windy conditions, both teams were in high spirits for the memorable occasion.

Although a newly-formed squad, QE got off to a promising start and took just ten minutes to net the opener, a well-taken goal by SC Allison.

The blustery Scottish weather played its part in the first half and kept most of the play out wide.

After a string of good passes by the musicians they slotted home the

equaliser and as the half went on the bandies continued to gather momentum and went into the break with a 3-1 lead.

The second half started with both teams showing great determination and team spirit, however this was short-lived as the RM band extended their lead due to a defensive mix-up in the QE box resulting in an own goal by PO Bach.

Further goals by PO Hilton and Lt Cdr Montgomery kept the score line semi-respectable – the band came away 6-3 victors.

The occasion was marked with the presentation of a Queen Elizabeth ship's crest to the band's Sgt Maj by WO1 Dave Smith, QE's Executive Warrant Officer.



# So near and yet so far in quest for success

## RN Seniors

THE Royal Navy drew against a strong Army side at Aldershot for the first match of the Inter Services.

Having enjoyed a good season in the Southern Counties Cup, the RN went into the double-header looking to take points forward in both the Cup and the Inter-Services.

The game didn't start well for the visitors when on 10 minutes, following a break down the left, the Army went a goal ahead.

This fired the RN into action and they equalised through an unstoppable Cpl Shea Saunders half-volley on 25 minutes.

The Army lead was re-established on 36 minutes, but on 40 minutes the RN were awarded a free kick 30 yards from goal.

Saunders struck a venomous shot which was too hot for the keeper to deal with; his spill allowed AB Leon Cashman to scoop the ball across to Cpl Dan Boere who bravely headed home.

Following the half-time restart the Army scored again to make it 3-2. But an inspired double substitution by the Lt Fraser Quirke/WO Paul Willetts management team saw the RN equalised with five minutes left on the clock.

Following a pass from man of the match POPT Danny Kerr, CPO Andy Todd coolly beat the Army stopper and slotted home.

The draw meant that the RN won the SCC league championship on goal difference, and gave them confidence for the



## ONLINE with Lt Mark Toogood, RNFA

RAF match.

Having not been in a position to challenge for the Inter-Service championship – going into the final game – in a number of years, a good start against light blue opposition at the Victory Stadium was imperative.

The first half was brought to a conclusion at 0-0. The second half started as the first had finished, but on 54 minutes the RAF established a vital lead.

A long ball over the top allowed an RAF striker to control the ball and race into the box; as he checked back the RN centre back attempted to challenge but was unfortunate in making contact on the attacker, who went down for a penalty.

Up stepped the RAF captain who placed the ball into the corner.

The RAF appeared to consider a one-goal lead sufficient. This allowed the RN to really get into the game and on 64 minutes AB Leon Cashman, put through by POPT Danny Kerr, struck a wonderfully timed shot from the edge of the box which whistled just wide of the post.

RN dominance continued and a CPO Andy Todd header, following a superb LPT Lee Foxhall whipped free kick, was saved by the RAF stopper.

The final genuine chance came on 81 minutes when a Cpl Ben Hebditch shot went

agonisingly wide.

The full-time whistle blew with the visitors a goal to the good and the RN's hopes of Inter-Services victory shattered. The championship was won for the fourth consecutive year by the RAF with a 3-2 win over the Army.

## RN U23

Following the 2-2 draw against the Army the U23s were also in a strong position to challenge for the Inter-Services title against the RAF at AFC Telford's ground.

On a heavy surface, the RN effectively used the momentum gathered from the Army game by starting positively.

The RN continued to press but were caught with a sucker punch on 27 minutes. The RAF broke down the right and squared the ball for their striker to place into the net from 16 yards.

With no team changes made at the break the second half was a closer affair.

In an attempt to push for an equaliser, ET(WE) Jamie Jackson was introduced and almost had an immediate effect – breaking clear only to be thwarted again by another fine RAF save.

Chasing the goal, the RN were left exposed and gave away a free kick on the edge of their own box. The resulting set piece was dispatched low past Mne Steve Cross to give a two-goal

advantage to the RAF.

Despite their 2-0 victory over the RAF the Army were disqualified from the competition for fielding ineligible players; therefore, by default the RAF took the title.

## RN Ladies

The RN Ladies commenced their challenge for Inter-Services glory at Aldershot, home of the British Army.

The RN got off to a blistering start with four shots on goal in the first 20 minutes, much to the surprise of the hosts, who were firm favourites.

AET Kayleigh Nardiello was making in-roads down the left wing and the NN Hannah Phillimore/LCH Helen Kingscott combination was dominating the centre of the park.

MA Susan Badger was tenacious up front, also pressurising the opposition.

After the interval the Army came out a different side and looked a real threat; however, the RN were giving it their all both physically and mentally and this determination paid off on 75 minutes.

Awesome attacking play created the space and a sublime pass to Badger allowed her to slot past the Army stopper for 1-0. The home side now upped the tempo, putting the Navy under increasing pressure, which led to an equaliser on 83 minutes.

A dubious refereeing decision gifted an Army free kick just outside the box and having drifted the ball towards the back

post an Army forward headed into the net.

The final seven minutes saw Army salvo after salvo with LH Lou Worsfold, the RN keeper, making some fine saves.

Naval grit finally bowed to Army dominance on 90 minutes, and a scruffy goal separated the two teams at the final whistle.

The Lt Rich Stephenson/POPT Sam Covey management team would have been proud of the performance but disappointed with the result – they would need to concentrate on the many positives if they were to raise the team for the RAF match.

Victory Stadium hosted the RN v RAF fixture.

Counter attacking became the order of the day in this flowing encounter with fine attacking play being nullified by strong defensive work ensuring neither side gained an advantage.

The second half started as the first had finished with both teams making attacking starts.

The final 10 minutes of the game went from end to end.

A mistimed RN defensive challenge just outside the box created a free-kick opportunity for the RAF; the resulting dead-ball was expertly saved by the impressive Worsfold to maintain the 0-0 scoreline at the final whistle.

Though the Army were the eventual winners of the competition following their 0-0 result against the RAF, this was the strongest competition performance from the RN to date.

# Are you ready for the peat-bog challenge?

ROYAL Navy personnel are being urged to take part in the 25th Cheviot 2000 challenge, a fell race set in the Northumbria National Park boasting 23 gruelling miles over all 11 peaks.

If that wasn't enough, there is a 5,000ft ascent and descent thrown in for good measure.

The event is run by members of the Northumbria Police Climbing Hills and Other Sports (CHAOS) Club and for those that have taken part in the challenge the 'Other Sports' seem to include bog-wading or snorkelling.

Open to all UK police officers and staff as well as the military and the other emergency services, the race has attracted a wide variety of determined, care-free and sometimes masochistic competitors over the years.

Designed for teams of three, entry is also permitted as a non-competing team of two or four. There are plenty of prizes to strive for with awards for the overall winner, fastest police, regular and reserve military teams as well as veterans, mixed and ladies teams.

There is a special prize of the 'Golden Welly' for the funniest or daftest action on the day.

The course record stands at 4 hours and 8 minutes and was set in 2011 by the Cheshire Police team. This was a rare year when the area was so dry that the peat actually became a springboard rather than the quagmire that usually welcomes the unsuspecting competitor who makes a slight error of foot placement.

Most teams will be pleased to be awarded the coveted 'sub 7' mug as 7 hours is a very respectable time.

For more information and to register go to [www.cheviot2000.com](http://www.cheviot2000.com) or contact Gary Saunders, Northumbria CHAOS Club, on 07971416557.

The deadline for entries is May 31 2014.

For those that navigate well, the event also includes a bit of history. Between the Cheviot and West Hill summits is the wreckage of a B17G Flying Fortress and is one of a number of plane crash sites in the Northumbria National Park.

The B17 was returning from an aborted mission in WWII when the pilot descended to "get a view below the clouds".

This resulted in the plane crashing onto the peat bog between the hills. Two of the crew were killed, remarkably the other seven crew survived.





● The Royal Navy and RAF boxers with guest of honour Capt Alistair Willis, Captain of HMS Neptune

Picture: LA(Phot) JJ Massey

## Navy fighters are lords of the ring

THE cream of the Service boxing world gathered at Clyde Naval Base for a sparring spectacular.

Fourteen of the Royal Navy and RAF's best fighters took part in the HMS Neptune Boxing Show, pitting their skills to determine which branch of the military are lords of the ring.

Over six hard-fought bouts, the Royal Navy were victorious,

winning every one of their fights against the RAF.

There was also an exhibition bout on the night between sailors and Royal Marines which saw the Commandos come out on top.

POPT Dave Berry, who helped organise the event, said: "It was a fantastic night of boxing. There is always a healthy spirit of competition between

the Services and each and every fighter gave it 100 per cent.

"On the night it was the Royal Navy boxers who wanted it more though.

"The results speak for themselves."

The Boxing Show, which was held in the Naval Base's Warrant Officers' and Senior Rates' Mess, also raised thousands of pounds for the Royal Navy and Royal

Marines Charity (RNRMC) and childhood cancer charity the Amelia Mae Foundation.

The show attracted 140 spectators who paid £50 each to attend a black-tie, four-course meal and to witness the boxing extravaganza.

"I would like to thank everyone who contributed to making the show a success," said POPT Berry.

## Bubbly day for new yacht

PRINCESS Michael of Kent named the new RNVRYC yacht Volunteer at Ocean Village, Southampton.

Accompanied by Prince Michael of Kent, who is the Admiral of both the RNVRYC and the Royal Southampton Yacht Club, the Princess poured Champagne over the bows of the newly-acquired Beneteau 40.7, watched by more than 90 RNVRYC members and guests.

Prior to the naming, the yacht and all who will sail in her were blessed by the recently-retired RN Chaplain Rev Bernard Clarke, himself an active sailor, in a form of service first used in 1589.

The RNVRYC is a recognised Service yacht club with close links to the Naval Club, Hornet Services Sailing Club and RNSA.

Membership is open to serving and retired members of the Royal Navy and Reserves, and boasts a membership of more than 400 from ABs to admirals.

Volunteer will be available for charter by suitably-qualified members of RNSA as well as the RNVRYC.

See [www.volunteeryachting.com](http://www.volunteeryachting.com)



● Princess Michael of Kent beside the yacht Volunteer

# Side downed by airmen in closely-fought games

## Aiming for T20 crown

THE annual feast of Inter-Services Outdoor Hockey took place as the Army 'hosted' the events at HMS Temeraire.

As defending champions from 2013, this was the Navy Senior Men's event to win or lose – and they duly lost 3-4 to the Army, having earlier drawn 3-3 with the RAF.

Probably more significantly, for the first time in 17 years, no Navy Indoor Command team had qualified for either of the two cast-iron tri-Service entries into the National Indoor Club Competition.

Certainly, the lack of availability of experienced players has hit the Navy harder than usual this season.

Prior to the competition, the RAF reckoned that they too had had similar availability problems – there was not much sign of it on the park, however, where the RAF won three of the five events (Men's and Women's Masters and U23/25 Men) and got second in the Senior Women's event.

One had sensed that a resurgence in Army hockey fortunes might just be imminent with the advent of a new chairman – still a feisty masters competitor and a former Combined Services cap from more than 20 years ago, Lt Col Dickie Head.

Sure enough, the Army won the two blue riband events at Senior level and got second place in both Masters, only coming an unexpected third in the Under 23/25 competition.

This must have been a source of great disappointment to veteran Army Juniors coach Pete Rosser, who would, however, have taken comfort in the Army Senior Men's win – practically all of them had been 'his' lads over the years.



● PO Mark Stanton (No 10) put the ball past the Army's goalie Dan Cattermole in a repeat of last year's encounter between the two sides

Picture: Lt Col Charles Jackman

The Navy's three last-place positions (Women's Senior, Women's Masters and Men's Masters) bore witness to the non-availability of experienced players – both Masters teams failed to manage a single pre-event training session.

The Senior Men's competition was really close; all three had some of their stars injured or serving abroad/not available.

All three teams had some excellent players and a number of newcomers.

Navy team coaches Sam Howard and the lately-impressive Conor McClure looked to have a good partnership.

The RAF were paying top coach Ian Jennings to bring out the best in their chaps and the Army would be very ably led by goalkeeper Dan Cattermole.

In the RAF/Navy opening match, Mne Kyle Pinnock fired in an unstoppable drag flick to put the Navy one ahead.

Welsh international Andy Seimann equalised for the RAF with a penalty stroke ten minutes later.

Immediately after half-time, two goals (one penalty, one corner) from Navy skipper, Scottish international Cpl Allan Gouick, looked to have sealed things for the RN with 20 minutes left at 3-1.

In the last eight minutes Seimann broke Navy hearts, putting away two penalty strokes for a very fine hat-trick and 3-3.

The RAF went on to beat the Army 2-0, so all rested on the Army v Navy encounter. It turned out to be a thrilling contest with no quarter asked or given.

PO Mark Stanton, so often a thorn in the Army's side, opened the scoring after just three minutes and the Navy had complete control until almost half-time.

With two minutes to go before the break, the talented Shane Vincent fired a corner into the roof of the net to equalise for the Army.

After the restart, a recent recipient of the Military Cross from Afghanistan, Mne Craig Buchanan, put away a penalty corner for a 2-1 Navy lead.

Vincent worked a bit more magic eight minutes later for the Army to draw level.

Within four minutes the Army's Rosco Wendover, spurred on by his ecstatic dad in the stand, gave the Army a 3-2 lead.

It took the Navy all of nine minutes to draw level with the impressive Mne Pinnock converting a penalty corner, making it 3-3 with 12 minutes to go.

Army skipper Dan Cattermole kept the Navy out time after time as they threw everything at him.

With six minutes left, an Army breakout saw Vincent complete a wonderful hat-trick, putting yet another unstoppable corner into the roof of the Navy net.

Cattermole made another three saves from Navy forwards, his performance winning his team the match and the competition, and himself the man of the tournament title.

Thus the Army Senior Men became Inter-Services Outdoor Champions 2014, and deposed champions the Royal Navy had to be satisfied with second place.

THE Inter-Services Twenty20 Tournament will be held at Lord's Cricket Ground on Tuesday June 3.

It's the seventh consecutive year that Services cricket has been hosted by Marylebone Cricket Club at Lord's, and the fifth year running for the Inter-Services Twenty20 Tournament.

The tournament is a triangular competition between the Royal Navy, Army and RAF senior XI sides, and is fiercely fought.

It is one of a few tournaments that provides the opportunity to watch three games of high-quality Twenty20 cricket in one day.

The Army will be looking to retain their crown, having won in 2013.

This year, for the first time, the day will include a women's match, with the Ladies Combined Services team playing the MCC ladies on the Nursery Ground.

Tickets are £15 for adults, £5 for under-16s and £7.50 for over-65s. Visit [www.interservicest20.co.uk](http://www.interservicest20.co.uk) or phone 020 7432 1000. A special 4-for-3 offer is available by using code 030614.

SSAFA is the supported charity.

Controller of SSAFA Air Vice-Marshal David Murray said: "SSAFA has been supporting the military community since 1885, and has been at the forefront of developing new services to meet changing needs.

"We support 50,000 individuals every year and our services are continually evolving to ensure we can meet their changing needs."

For more information please visit [ssafa.org.uk](http://ssafa.org.uk), or text 'CRIC14' £5 to 70070 to make a donation.



# Delight and despair for Navy's rugby teams

## Power show by RN

THERE were mixed fortunes for Royal Navy rugby teams, with the Men's Senior XV recording a huge victory while the RN Women endured a heavy defeat.

The men's side recovered from back-to-back defeats to thrash Devon RFU 45-20.

The RN finished the first half 26-3 ahead, thanks to tries by AET Kye Beasley (RNAS Culdrose), Cpl Gaz Evans (3 Cdo) and Mne Nathan Huntley (40 Cdo).

The start of the second half saw a fresh injection from the bench for Devon and they dominated the early play, scoring two tries.

The Navy recovered some control with a try from AET Jon Humphrey (RNAS Culdrose).

Shortly after, a quick ball was picked up by Evans, and his side-step and acceleration saw him go over for a try from 30 metres out.

Devon rallied and scored before the Navy did exactly the same in injury time to leave the final score 45-20.

The RN Women lost 10-32 to Trojans in an exciting match at HMS Temeraire.

The early exchanges were evenly matched. The returning Loz Morton made one telling break through the middle, which allowed the RN Women to put some real pressure on Trojans.

A midfield break from half-way allowed Trojans behind the home team's defence and some good handling saw them score a well-taken try, which they were unable to convert.

This was followed shortly after by a second, extending their lead to 10-0.

The set-back galvanised the RN Women. The forwards were beginning to carry strongly, with Stacey Hargrave and Paula Bennett-Smith particularly prominent.

However they were unable to produce the quick ball for the backline to use effectively, and too often an unforced error would allow Trojans to regain possession.

It was from one of these turnovers that Trojans scored their third try.

The Navy team, though, were to have the last say in the half – from the kick off, and with little time before half-time, they were once more on the front foot.

This time they were able to capitalise on their possession and from a couple of half breaks produced by the strong running



● Above left: Andrea Marshall tries to fight her way through a Trojan tackle

● Above right: Stevo Stevenson scored the RN Women's second try

● Right: Loz Morton crosses for the Navy's opening try

● Left: Stacey Hargrave battles a strong Trojans defence

Pictures: Geraint Ashton Jones

forwards, Morton was able to cross for a well-deserved try.

Half-time, and the Navy trailed 15-5.

The second half was, in very many ways, similar to the first. Trojans proved robust in defence and had the pace to hurt the home team when their defence lapsed, with their right wing and openside flanker particularly impressive.

Having conceded an early score in the half the RN Women once more took the game to Trojans.

Morton was again proving

a handful whenever she had possession and the work rate of Caroline Penrose and Nik Williams ensured that a steady supply was forthcoming.

In some ways this was the best period of the match for the home team as their error rate was reduced and they were able to build a few phases.

This in turn asked more questions of the Trojans' defence and eventually Helen Stevenson was able to cross for the RN Women's second try to bring the score back to 22-10.

One for the record books, as

there will not be many matches where she scores playing centre, rather than her usual home in the back row of the pack.

Ideally the RN Women would have looked to build on the score but a long couple of days training began to take their toll and the final quarter belonged to Trojans.

With the home side falling off a couple of midfield tackles the Trojans ensured that the RN Women were pinned in their own half.

Two final scores put a gloss on the 32-10 score in a match where both teams had contributed to

an enjoyable open game for the spectators.

Though the RN Women left the field disappointed they have enough to be optimistic about. Some of the missing balance will be resolved when other players return. This should also tighten up the defence a little as fewer players will be out of position.

**RN Women:** Pam Williams-Wilson, Emily Park, Kate Parkman, Nik Williams, Stacey Hargrave, Caroline Penrose, Elle Bloor, Paula Bennett-Smith, Emma Swinton, Sam Alderson, Andrea Marshall, Loz Morton, Helen Stevenson, Laura Blagdon, Lizzie Grant Rees, Amy Risher, Lisa Christie, Vic Percival, Zoe Harrop, Katie Ives, Alice Kightly, Taranaivini Tuivaga

THIS year marks the 25th anniversary of the BDFPA (British Drug Free Powerlifting Association) and, with more than 150 athletes, this year's British Championship was the largest event to date.

The RN raised a team of six lifters, pitting their strength against the best in Britain.

At 75kg Mne Mark Hourston made his national debut with an impressive 175kg squat, 130kg bench and an incredible 232.5kg deadlift, more than triple his bodyweight, for a 537.5kg total. Mark took third place in his weight class.

At 82.5kg were CH(SM) Wes McGuinness and Mne Sam Dew.

Wes was also a newcomer at national level and attempted a 205kg squat but it was not to be.

Sam, the 2013 World Champion, was on fire with a massive 250kg squat, a mind-boggling 170kg bench press (more than twice his own bodyweight) and a 255kg deadlift – setting world records in the squat and bench press, and for his 675kg total.

Competing at 90kg was last year's junior British 82.5kg champ AET Reece Meakin. He managed a 210kg squat, 157.5kg bench press and 260kg deadlift.

With a 627.5kg total he secured the Junior British title, coming third overall.

At 110kg was another national debutant, Lt Jovin Harper, and LMA(SM) Chris Martin.

Jovin squatted 220kg, benched 137.5kg and pulled a 260kg deadlift for a 617.5kg total. Chris achieved a 210kg squat, 150kg bench and 245kg deadlift for a 605kg total.

Sam, Reece, Mark, Jovin and Chris all qualified for the European and World Championships later this year.

For more information on Royal Navy Powerlifting visit [www.royalnavypowerlifting.co.uk](http://www.royalnavypowerlifting.co.uk)

## Anyone for tennis?

TENNIS fans are being urged to turn up and support players at the RNLTA past vs present tournament at Portsmouth Tennis Centre on June 28.

The association's preparations for the coming season included a successful training camp in Cyprus.

Highlights this season include the Royal Navy Tennis Championships from July 10-13 and the ISAs Championships AELTC on August 4-5

The season will end with a taster session in real tennis at Radley School, Oxfordshire.

## Top titles in their sights

ROYAL Marines joined 18 organisations, including the CIA, in a shooting competition in North Carolina.

The titles of best rifle and pistol marksman were up for grabs at the US Marine Corps Base Camp Lejeune.

"We're invited to shoot against the United States Marines every year," said Cpl David Marlow, from the British Royal Marines marksmanship team.

"I've learned a lot since being here. I'm glad I got the opportunity to come here and participate. I've had a great time shooting and learning from the Marines."

The goal of the programme is to enhance combat marksmanship proficiency. The competition serves as an 11-day training period for Marines to refine their marksmanship skills under



● A British Royal Marine in action at Camp Lejeune

the more stressful, demanding conditions of competition.

Weapons used included the M16-A4 rifle and M9 pistol.

Participants competed in the Individual and Team Rifle Match, Individual and Team Pistol Match for the Royal

Marines Bowl, Inter-Corps Cup and Wirgman Trophy.

The Marines were also given the opportunity to complete their annual rifle and pistol qualification and earn distinguished shooting badges for their Service and dress uniforms.

**Calling all Leading Medical Assistants or above, are you ready?** | **Calling all Engineers and Technicians - The Offshore Industry needs you.**

If you're already a Leading Medical Assistant or above but want to make more of the opportunities currently available within the 'Oil Industry' you will need to be qualified as an

**HSE Offshore Medic.**

This 20 day HSE approved Advanced Skills course costs £2050 and includes:

- HSE Certification
- Clinical attachments
- Modular Training
- Manuals and materials

Do you hold a formal 'Technician or Engineering' qualification or have completed a 'Trade Apprenticeship'? Are you looking for a highly paid, exciting position as an

**Offshore Dive Technician.**

Do you like worldwide travel? Would you like 50/50 working/ time at home? If the answers are yes then you will be eligible to start working in the Offshore Oil & Gas Industry as a Technician after completing one of our Dive Technician courses.

**Courses available are:**

- Dive Technician - Foundation
- Dive Technician - Air Diving Systems
- Dive Technician - Saturation Systems

**Call Interdive on +44(0)1752 55 80 80 for course bookings or visit the web site at [www.interdive.co.uk](http://www.interdive.co.uk)**



# WAITING FOR THE STORM

Planning and preparing for Operation Neptune

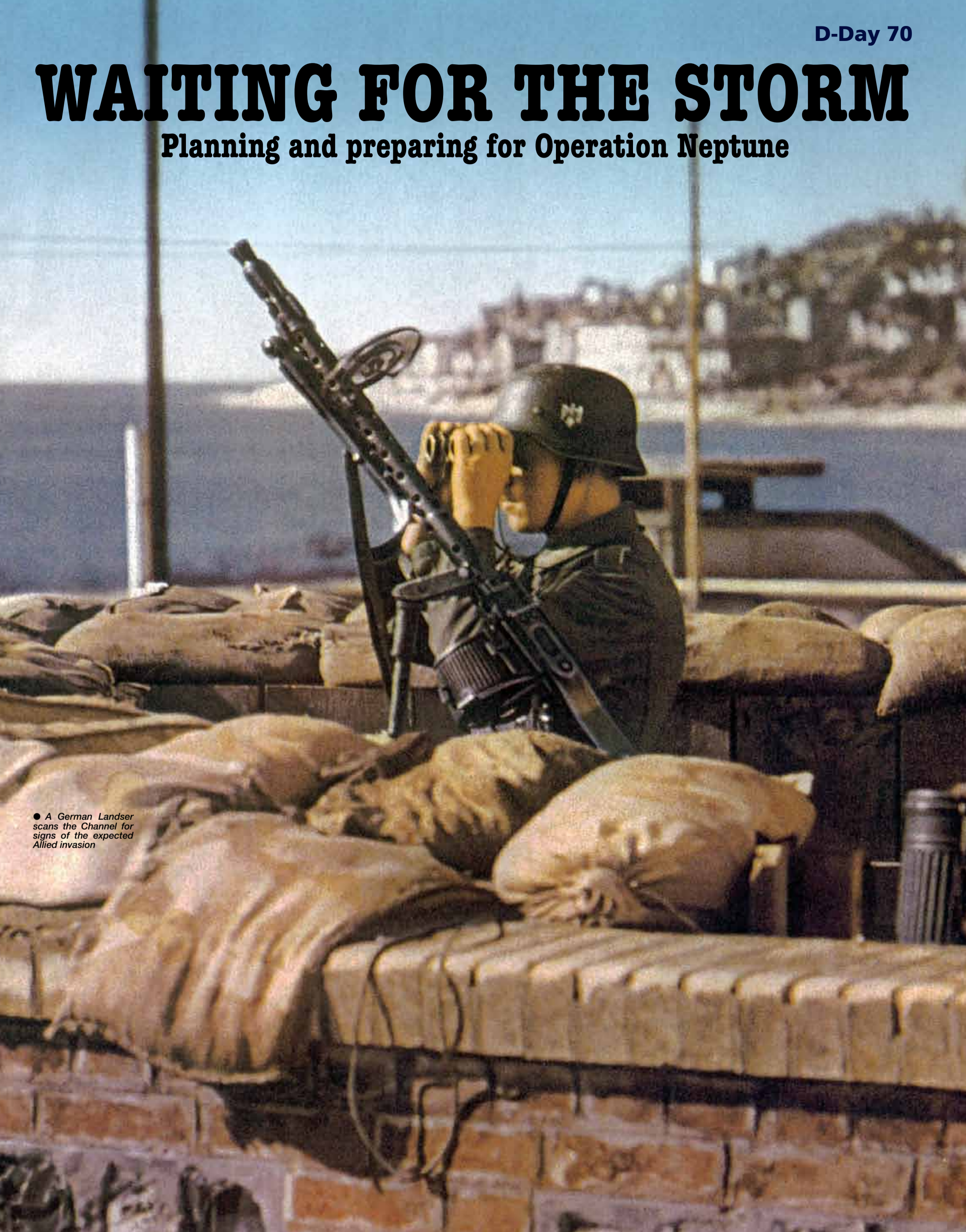

● A German Landser scans the Channel for signs of the expected Allied invasion



## Why was Normandy chosen for assault?

ONCE the Allies had decided that a Second Front in north-west Europe was to be created, a filtering process began which reduced the number of possible assault sites to a shortlist of candidates.

The invasion of Europe by the Allies would first have to breach Hitler's *Atlantikwall* and establish a stronghold of their own before they could contemplate a break-out.

The Atlantic Wall stretched from the northern coast of *Festung (Fortress) Norwegen* to the Franco-Spanish border, and officially came into being in March 1942 after 'Führer Directive Number 40'.

At first the Channel and North Sea ports were given priority, with *Organisation Todt* (OT), the Nazi engineering and construction organisation, given a high-impossible task of creating thousands of fortifications, bunkers and defensive installations in just a year.

Having estimated that fewer than half of the target could be completed in the timeframe, OT set about its task, using hundreds of thousands of forced labourers to create a defensive shield in Holland, Belgium and France through 1942 and 1943.

Hitler's strategy seemed to be justified after the Dieppe Raid of August 19, 1942, when an Allied task force attacked the French port. It was a disaster.

Armoured vehicles trundled ashore but could not get off the beach as assault engineers failed to breach the sea walls.

Caught in brutal crossfire from well-planned defensive positions, Allied soldiers – mainly Canadian – were mown down.

Fewer than half the 5,000 troops returned to the UK after the nine-hour bloodbath, leaving behind them all 28 of their tanks and 33 landing craft.

More than 100 Allied aircraft failed to return, against 48 German losses, and a destroyer was sunk in the Channel.

While Germany exulted in the victory, they failed to see the clear lessons that the Allies had learnt in painful defeat.

It was only in late 1943, when seasoned campaigner Erwin Rommel was brought into the equation, that the spotlight was turned to the relatively weak coastal defences between the fortified ports and harbours.

Hitler's dream of a shield of steel and concrete had been fading as the Eastern Front and the new threat to the Axis powers in Italy drew valuable resources away from France.

But the Führer appreciated the threat in the west and promised a renewed effort.

As the Allies planned and rehearsed across the Channel, the Germans sped up the construction of the Atlantic Wall.

Rommel believed the Allied invasion had to be repulsed at the water's edge, before reinforcements weighed in.

His plan was for defence in depth – a strip of coast five or six miles wide strewn with minefields, machine gun nests, mortars, artillery and anti-armour traps, backed by tanks.

But for the Allies, the process of selecting landing sites was relatively simple.

Ports were out. The sites had to be within range of UK-based fighter aircraft. Beaches should be shallow, with a low hinterland. There had to be easy exit routes from the beach, and from the wider beachhead.

That ruled out Norway and much of Holland and Belgium.

In fact, it left just two realistic options – the Pas de Calais and the Bay of the Seine.

# Invasion was open secret

EVERYONE knew the so-called Second Front – the Allied invasion of Europe – was coming.

The Germans were certainly expecting it – in September 1942, just after the Allies' failed Dieppe raid, Hitler declared: "The enemy will not abandon attempts to form a Second Front, for he knows that it is the only chance he can still achieve total victory."

"Therefore, I regard it as my mission to do everything humanly possible to improve the defensive capability of the coast immediately."

Just a month previously, Heinrich Böll – a future novelist and Nobel prizewinner – was on duty on the Normandy coast: "The four hours on duty this evening were very wet and stormy by the sea and cold, cold, despite being August."

"The sea was extremely restless, the surf wild, and if Tommy had come, we would have neither seen nor heard him, so dark was it."

"The motorboats roared around in the Channel and sometimes we saw a red flare somewhere, a distress signal; *ach*, we were happy when our four hours were up..."

"We wait, every night we wait for Tommy, but he doesn't seem to want to come yet."

"I am really curious to see if he will come in the end."

Despite the secrecy surrounding plans for Operation Neptune, it was really only a matter of where and when.

Detailed plans had been initiated as early as spring 1942 as Churchill sought to engage the Germans in western Europe, forcing the Axis to face two formidable forces on two widely-separated fronts – Hitler was already mired in bitter fighting in the East against the Russians.

When Italy collapsed in mid-1943, a drive up through Southern Europe into the Nazi heartland also became a viable option, proving a further headache for the commanders of the Third Reich.

But the strongest case for a counterattack was always going to be an operation launched from Britain, where men and materiel could be gathered in vast numbers and relative secrecy, from where a significant assault could be launched and – just as importantly – from where troops on a breakout could be supplied and reinforced in sufficient volumes.

Operation Overlord was the codename for the general



● One of the four 152mm naval guns at the Longues-sur-Mer battery between Gold and Omaha beaches. Part of Hitler's Atlantic Wall, the battery was completed less than two months before D-Day, and was out of action by 7pm on June 6 1944

liberation of north-west Europe, but of particular interest to the Royal Navy was Operation Neptune – the amphibious assault phase on which Overlord depended, the central feature of which is now more widely known as D-Day or the Normandy Landings.

But Operation Neptune was not just about June 6 1944 – the most complex Naval operation in history required months of detailed discussion and a logistical programme of incredible scope and magnitude. Initially known as Operation Round-Up, the planning process for Neptune began under Admiral Sir Bertram Ramsay.

Ramsay was the ideal candidate, having already proved his mettle in an operation which featured many elements that would form an integral part of Neptune but which was essentially an assault in reverse.

As Vice Admiral Dover in the early years of the war Ramsay had been responsible for protecting traffic in the Channel, and had

planned Operation Dynamo – the Miracle of Dunkirk – the astonishing evacuation of Allied forces from the beaches of Dunkirk in May and June 1940.

Under his overall control, in just nine days around a third of a million Allied troops were rescued from northern France, where they had been surrounded and were on the verge of being wiped out as a fighting force.

Soldiers were picked up from the port of Dunkirk and nearby beaches using a mix of small craft and bigger merchant ships and warships, shuttling to and fro under the threat of attack by air, sea and land-based artillery – though a vast arsenal of had to be abandoned.

Ramsay went on to marshal forces around the south-east corner of England to counter a possible German invasion.

When that threat passed and the Allies started to look at returning to the mainland of Europe, Ramsay started plotting that invasion, but when that was postponed, he moved on to crucial roles in the amphibious landings in North Africa (Operation Torch) and Sicily (Operation Husky) before returning to Neptune in October 1943.

By that stage a conference in London, which included senior American and Canadian army officers, had made firm decisions about the planning, training and provision of equipment which formed the basis of the first formal blueprint for Neptune.

This blueprint, approved by the Combined Chiefs of Staff, was adopted by Churchill, and Roosevelt at the Quebec Conference of 1943 (codenamed 'Quadrant'), which also covered the development of the atomic bomb.

Detailed planning for Neptune began on December 15 1943, although the appointment of Gen Bernard Montgomery as commander of Allied ground forces for Overlord led to significant – and rapid – revisions over the festive period.

The pace picked up again on January 14 1944, and on February 1 an initial joint plan was issued, followed two weeks later by a specific Naval document – the basis of Operation Neptune.

This plan asserted that the Allies would attack the Normandy coast to secure "as a base for future operations a Lodgement Area."

The Lodgement Area would quickly become a military powerhouse, receiving troops, equipment and supplies and turning them into an army which would fan out from Normandy and finally crush Hitler's doomed empire, meeting up with the Red Army in central Europe.

Provisional Naval orders went out on April 2, and on April 24 the first sealed orders were issued to Naval commanders.

Two days later the Allied Naval Commander Expeditionary Force (ANCF) – Admiral Ramsay and his team – moved to Southwick Park on the slopes of Portsdown Hill, north of Portsmouth.

On May 12 the Naval plan was 'frozen' – the main elements were now in place, and only minor tactical changes would be accepted.

By that time Ramsay had told Gen Dwight D Eisenhower, the Supreme Allied Commander for the Allied push into Europe, that June 5 or 6 were the earliest acceptable dates for the assault, with June 7 earmarked as a possible reserve date.

Those who had been issued with sealed operational orders were told to open them on May 25, and three days later the vital, final piece of information was added to the jigsaw – D-Day would be June 5.

The basics of Operation Neptune were straightforward, if challenging.

Five divisions would be transported and escorted across the Channel to land at five beaches, with airborne troops securing the flanks of the assault area while warships and aircraft set up an impenetrable barrier on both sides of the convoy route.

Minesweepers would clear two channels for the assault armada, and warships would cover the landings by bombarding defences with their big guns.

Oh, and two massive prefabricated harbours would be built from scratch to supply the break-out from the beachheads...

## The D in D-Day stood for nothing

D-DAY is a term that has gained iconic status – but it was not coined specifically for Operation Neptune, and was used in its original generic military context during World War 1.

The D in D-Day does not stand for 'deliverance', 'doom' or 'destiny'.

It does not stand for any word at all – it is simply an alliterative phrase which represents the crucial date in plans for a military operation, which could just as easily have been designated X-Day or any other random letter of the alphabet.

Similarly, H-Hour was a common military term for the exact time at which the operation started.

Designating a date and time with a letter works in the same way as algebraic terms.

Complete, detailed plans for the operation can be worked out and disseminated to the various participants well in advance without the need to identify a specific date.

Thus points of time before the start are referred to as minus figures – D-5 means five days before the date of the start of the operation – and those after as plus figures – D+14 was two weeks after the landings.

It also means the date can be switched at short notice without the need to rewrite the plans – as was the case with Operation Neptune.

Up until an adverse weather forecast was made on June 3, D-Day was to be June 5. On the advice of the meteorologists, the invasion was delayed for a day; instead of a mass rewriting of plans, a simple signal was required to say D-Day was now June 6, and all the other dates – D+4, D+7 and so on – flowed from that.

As to the British names of the operations for the invasion of Europe, **Overlord** was the overarching plan which came into being as the first troops landed in Normandy and ended with the liberation of Paris on August 25 the same year.

**Operation Neptune** was the naval part of Overlord, transporting and protecting the vast majority of the troops, armour and supplies which fed Overlord, while the airborne assault by British paratroopers and glider-borne troops was named **Operation Tonga**.

Other key operations before and during Overlord included: **Operation Bodyguard**: the overall deception strategy to hide the true scale and destination of the Allied invasion force.

This was further divided into specific operations, such as **Fortitude North** (the feint on Norway) and **Fortitude South** (plans to fool the Germans into thinking the main attack would be made in the Pas de Calais).

Other deception operations undertaken by aircraft included **Taxable** and **Glimmer**, when strips of metal chaff ('window') were dropped within range of German radar stations to create false contacts.

On D-Day itself the well-oiled, successful glider attack on the bridges over the River Orne and Caen Canal in the early hours – which had to be held intact to ensure an exit route for Allied troops while preventing German tanks from attacking the beachheads – was dubbed **Operation Deadstick**, and saw the liberation of the first piece of French soil – the Café Gondree, near what is now known as Pegasus Bridge, in honour of the liberating paratroopers' emblem.



● A German soldier from 302 Infanterie Division surveys the carnage of dead troops and wrecked tanks at Dieppe, August 1942

● (Right) Admiral Sir Bertram Ramsay (left), the officer in charge of Operation Neptune, with Rear Admiral Philip Vian, Commander of the Eastern Task Force





## Training essential to success in France

ONE of the pivotal tasks of the modern Royal Navy is the ability to create and deploy an amphibious force.

From initial reconnaissance missions through training to the assault itself, the Senior Service is configured to deliver a devastating and co-ordinated blow at speed using well-trained personnel and purpose-built ships and equipment.

A little over seven decades ago, that capability would prove crucial in ridding occupied Europe of the Axis scourge.

In 1942 the art of amphibious assault was still relatively new.

True, there were plenty of examples of Jack and Royal (in his various guises), with or without army support, going ashore in small raiding parties using ship's boats or larger forces, such as the siege of Quebec in 1759 and the taking of Minorca 34 years later.

But a true amphibious landing (generally described as 'combined operations' by the British military, particularly when land, sea and air forces work in unison) using bespoke equipment was arguably first seen at Gallipoli during World War 1 (though little was done to build on this campaign in the inter-war years).

This 1915 venture demonstrates another feature of amphibious assaults – the need for close co-operation between the various fighting arms, and the need to rapidly reinforce and expand the beachhead.

For while thousands of troops poured ashore on April 25 1915 (the initial assault was delayed by the weather – as it was in France almost 30 years later) on the Turkish peninsula, very little effort went into breaking out and taking the fight to the enemy.

Commonwealth and French troops at Y beach were virtually unopposed, while soldiers emerging from SS River Clyde, a converted collier, at W Beach were almost obliterated – emerging in single file onto the landing ramps, they were cut down by machine gun before they even set foot ashore.

Once the invaders were on the beaches, that is pretty much where they remained.

With the initial impetus lost, and often camped on the beaches, the attackers' inactivity gave Turks time to reinforce their defences – and with Gallipoli mired in stalemate, the invading force was withdrawn the following January.

Not a glorious venture – but one which yielded significant pointers towards how an assault should be mounted.

Detailed planning between all participants was essential. Air cover would be a huge asset, both for attacks on the enemy and for intelligence-gathering.

The art of amphibious landings could no longer be trusted to keen amateurs – the landing craft crews, the force commanders and the senior logisticians would all have to be familiar with and well-drilled in the complexities of seaborne assaults, and troops rehearsed in the techniques of assault by water.

Naval bombardment – naval gunfire support in modern parlance – would prove particularly effective.

And, most important of all, was the acceptance that the assault phase was not a goal in itself, but just the start of a process.

Troops ashore were of little use without supplies as they sought to keep the enemy on the back foot, breaking out rapidly and relying on fresh troops to reinforce the advance.

All of which helped shape the plans for Operation Neptune.



● American soldiers train for the Normandy landings at Slapton Sands in Devon

Picture: Library of Congress

# Tragedy in the Channel

AS TRAINING gathered momentum at camps and coasts around the UK in late 1943, thoughts turned to 'dress rehearsals' for the landings in Normandy.

Plans are just paperwork until men and machines bring them to life, whether it be a few chaps hopping out of a mock-up of a landing craft ramp into a puddle or full-scale mock attacks by divisions fighting side-by-side.

'Training' does little to capture the scale and breadth of the preparations before June 6 1944.

Spearhead troops learned how to embark and disembark, minds concentrated by live fire, on beaches similar to those of Normandy.

Landing craft crews learned how to handle their vessels, possibly at a converted holiday camp on Hayling Island, or maybe on Southampton Water at Warsash or in other sheltered bays and inlets along the coast.

Support vessels were put through their paces off Dorset.

This basic training carried on through 1943, while the scope and scale of the exercises became more ambitious.

Stretches of beach which resembled the beaches of Normandy, large enough to stage divisional landings, were identified and taken over as training grounds.

Three were in Scotland – Tarbat Ness, Culbin Sands and Burghead Bay, around the Moray Firth – one in South Wales on the Gower peninsula, and one at Slapton Sands in Devon.

Hundreds of residents were moved from the Scottish sites, which were used by the British forces who later landed on Sword Beach, although the stormy winter of 1943-44 was not conducive to training for the conditions expected in the late spring or summer of 1944.

Slapton was the domain of the Americans, as it closely resembled the terrain the soldiers would face at Utah beach just weeks later – a shore backed by a shallow lagoon with low bluffs inland.

A considerable number of people had been moved from the area – live ammunition was used by troops and bombarding ships.

Within a couple of weeks of the last of the 3,000 residents packing up and leaving (they would not return for almost a year), the Americans staged Exercise Duck 1 on January 3 and 4 1944.

Exercises Duck 2 and Duck 3 the following month built on a slow start.

March saw Exercise Fox, involving 17,000 troops, during which the capability of the DUKW amphibious truck as a cargo carrier was tested.

Planning for Fox was delayed

to incorporate aspects of the plans for Operation Neptune, and as such the programme suffered some limitations – as was the case with Exercise Beaver in late March.

That saw airborne elements introduced (the paratroopers were actually dropped off by Jeeps) but the exercise was muddled, and confused soldiers failed to complete their missions.

Other minor exercises included Otter and Muskrat.

But next came the first of two major dress rehearsals for D-Day – Exercise Tiger, a chance for Force U to carry out an ambitious large-scale landing before they were unleashed on Utah beach in Normandy.

High-level planning for Tiger began in February, and allocated troops – 25,000 men and 2,750 vehicles – entered marshalling sites around Plymouth, Dartmouth and Torbay on April 22, ready to assault Slapton a week later.

During the night of April 27-8 follow-up convoy T-4, consisting of eight LSTs (Landing Ship Tank), was cruising at six knots south-west of Portland, heading back towards Start Bay to drop off support forces, including engineers and HQ staff.

They were protected by a picket line across the mouth of Lyme Bay consisting of two destroyers, two MTBs and two MGBs, provided by CinC Plymouth.

Escorting them was corvette HMS Azalea, although a further escorting destroyer had returned to port after a collision, and a replacement was not assigned until it was too late.

A flotilla of E-boats, on patrol from Cherbourg, evaded the screen and spotted the convoy.

One factor in the disaster was thought to be that the LSTs and the escorts were mistakenly operating on different radio frequencies, so the landing ships did not pick up vital warnings.

Some time around 2am the E-boats fired torpedoes at the lumbering LSTs, hitting four.

The torpedoes which struck LST 511 failed to explode but LSTs 507 and 531 were not so lucky, bursting into flames – the former was finished off by a warship, the latter sank within six minutes.

LST 289 was badly damaged but limped back to Dartmouth.

A total of 551 soldiers and 198 sailors died – 749 men in all, ironically more than three times the death toll that Force U would suffer on D-Day itself. A further 300 or so were injured.

With other forces still to undertake their dress rehearsal and secrecy around Op Neptune at its strictest, news of the Tiger calamity was not made public until late July or August, long after the Allies had established themselves in France.

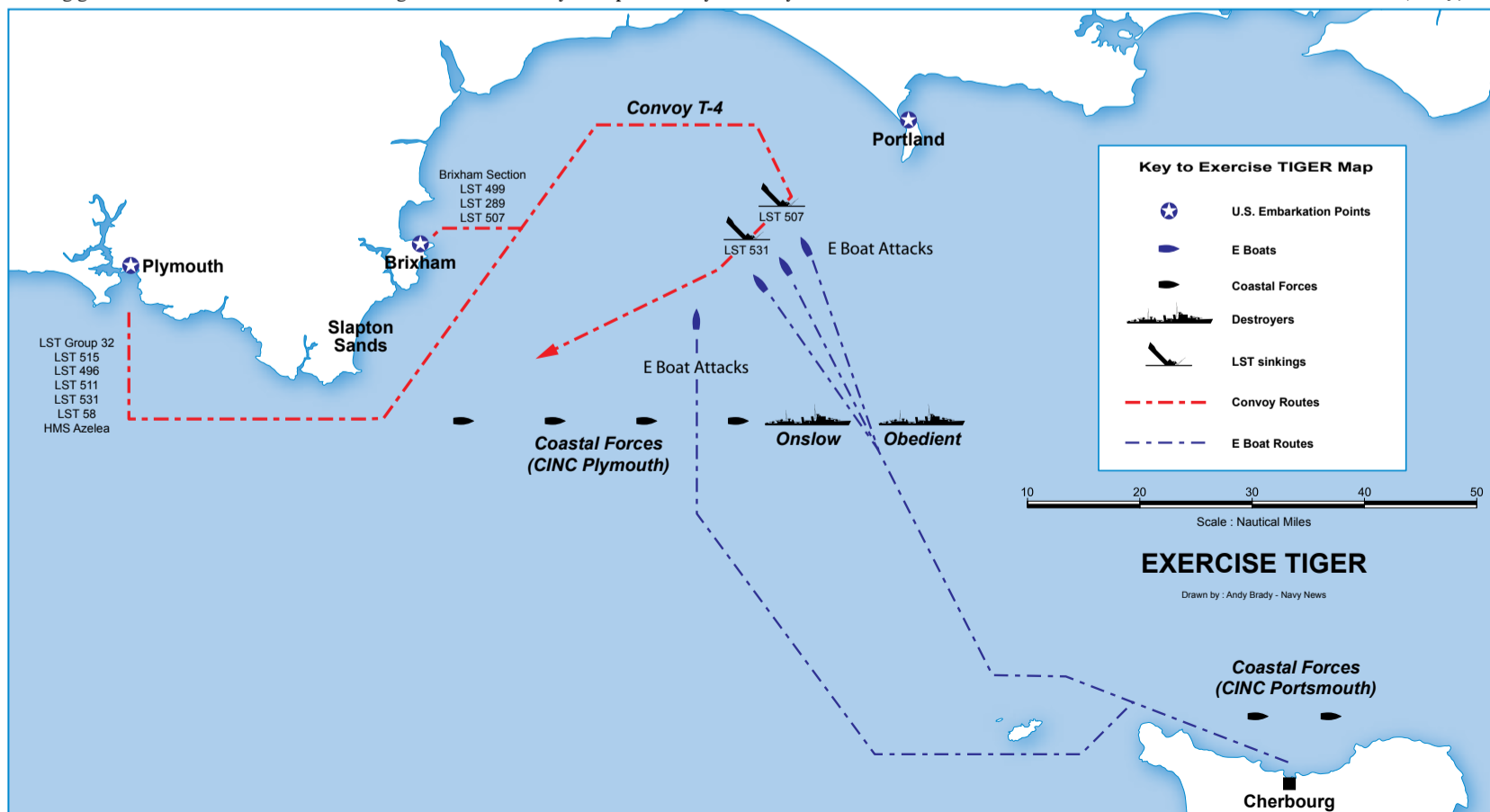

## Building expertise for D-Day

AS IS the case in the 21st century, training for an amphibious assault is gradually built up in scale and complexity.

A training programme for the Royal Marines of 3 Commando Brigade in 2014 might start with small-scale rehearsals, perhaps moving on to a 'wader' exercise – essentially a larger venture but carried out in slow-time.

These build up to a full-scale rehearsal when land, sea and air forces come together to prove their capability.

This capability – unique to the Naval Service – is ready for use by the British government at short notice, in the shape of the Response Force Task Group, and in men and women who are trained from the start in the skills required of such warfare.

And the effectiveness of such training and equipment was demonstrated in recent times on the Al Faw peninsula, at the start of the Iraq War in 2003, when a near-textbook combined operation reaped rapid rewards.

The only difference seven decades ago was the fact that a full-scale rehearsal was impossible – Operation Neptune was the largest and most complex amphibious landing in history, and is likely to remain so for all time.

In that case training was a vital factor in the success of the assault – many of the participants were scripted warriors, not necessarily well-versed in the art of war, and would need to be rapidly drilled in this most skilful of manoeuvres.

Accordingly, groups of men were trained in various skills.

Communications training was vital, not least because of the number of nationalities involved and the need for tight co-ordination.

Landing craft crews went through their drills at Hayling, on Southampton Water and elsewhere, while their officers were moulded in the West of Scotland.

Support bombardment was the subject at Larkhill and Whale Island, while East Anglia and the South of England saw troops training up to divisional level.

It all built up to a menagerie of exercises in the Channel, one of which – Exercise Tiger – resulted in massive loss of life (see left).



# Instant guide to Mulberries

# No harbours

**Mulberry** – the codename for the two artificial harbours used as part of Operation Neptune. The components (see below) were manufactured in Britain then towed to Normandy for assembly.

**Gooseberry** – sheltered water provided by sinking Corncock blockships to form five artificial reefs or breakwaters, protecting the Neptune landing beaches after D-Day. Gooseberries 2 and 3 were the basis of the breakwaters for the two Mulberries.

**Corncocks** – the old, redundant freighters and warships used to form the Goosberries.

**Cob** – a convoy of Corncock blockships.

**Bombardons** – floating steel breakwaters. Their construction required 25,000 tons of steel, and at peak times up to 16,000 men were involved in prefabrication and construction.

**Phoenix** – concrete caissons sunk inside the Bombardons at Arromanches and St Laurent to form a solid breakwater. At peak construction points the project employed up to 23,000 men, half of them labourers.

**Spud** – concrete pierheads with motorised legs allowing them to rise and fall with the tide. It is estimated that 300 firms were involved in the prefabrication of the pierheads.

**Whale** – the collective term for the pierheads and flexible road spans to unload ships at the Mulberries. The flexible roadways alone required the output of 250 firms as well as soaking up much-needed metalwork and welding expertise in the UK.

**Beetle** – steel or concrete floating units to link the Whale road spans. 470 concrete Beetles were built, and 230 steel.

**Camel** – inflatable pontoons which temporarily supported the ends of Whale roadways while Beetles were replaced.

**SLUG** boats – Surf Landing Under Girder shallow-draft motorboats designed to work under the Whale roadways, attending to anchoring cables and replacement of Beetles and Camels.

**Rhino** – powered pontoon ferries by which vehicles and stores could be brought ashore by water rather than using the Whale roadways.

**DUKW** – 2.5 ton amphibious Army trucks for ship-to-shore transportation, capable of carrying a load of 25 troops and equipment or five tons of cargo. They could reach over five knots in water and 50mph on land.

The two **Mulberries** were planned for **St Laurent (Omaha Beach)** – **Mulberry A** – and **Arromanches (Gold Beach)**, **Mulberry B**. The codename for the operation at Arromanches was **Golden Arrow**, taking the name of the beach and the first element of the town's name.

Construction of the **Mulberries** required over **1,000,000 tons** of reinforced concrete

**Phoenix** sinkable caissons displaced between **1,600 tons** and **6,000 tons**, depending on their role.

Operation Neptune ultimately called for **213 Phoenixes**, although the final number produced is uncertain as some were damaged during construction and others sank before being planted in Normandy.

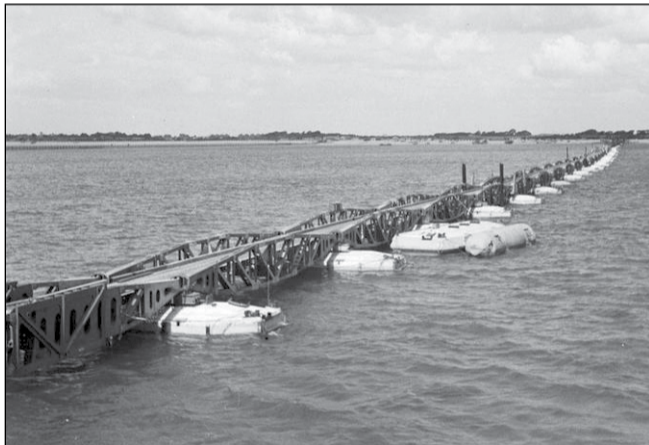

● Part of the Whale flexible roadway of a Mulberry Harbour, supported by Beetles

## A WILDLY fantastical plan conceived to solve an intractable solution.

An engineering project that required more steel, concrete and space than could be made available to complete the task.

A massive construction programme spanning months, in factories and harbours across the country, creating huge structures that had to remain a total secret.

A pivotal juncture in the war where success could hinge on a combination of brilliant vision and mad coincidences including a bobbing lilo and a maverick 6,000-ton block of concrete that ran aground in the Solent...

While the Allied assault on D-Day itself was a defining moment in the war, what followed was an industrial *tour de force*.

Because once the spearhead of troops was ashore, and had established a beachhead, it was vital that in the hours and days afterwards there should be a constant supply of men, equipment and stores to prevent the initial assault from stalling.

Accordingly, one of the key considerations of Operation Neptune was ensuring the use of a sheltered deep-water harbour – the original plan, produced in September 1943, specified a daily capacity of 12,000 tons of cargo and 2,500 vehicles by D+14 and the ability to handle deep-draught Liberty ships.

There were two such ports in the region, Cherbourg and Le Havre.

But the risks of a full-frontal assault on a heavily-defended port had been painfully demonstrated by the disastrous Dieppe Raid of 1942, where a force of over 6,000 troops suffered around 60 per cent casualties – around 900 of them killed – in a venture which proved that the Allies were not yet ready to invade Europe, and particularly not through an established port.

Even if such an attack succeeded there were other considerations – a force invading through Cherbourg could be bottled up by relatively-small enemy formation on the Cotentin Peninsula, and at Le Havre an Allied force would have to fight on land divided by a wide river.

The retreating Germans would, in any case, certainly render port facilities unusable for months by destroying everything of value.



● Phoenix units under construction at Stokes Bay in Gosport, on the Solent, using hards which would later be used to load troops and vehicles on to landing craft

Picture: © IWM (H 035554)

So if the ports were ruled out for the assault phase, the logistical link would have to be across the beaches until such facilities could be secured from landward – but that left the supply-line at the mercy of the weather.

So a third alternative was the only answer, combining the advantages of a deep-water port with the weaker German opposition on the sloping beaches of Normandy.

The solution? Bring your own prefabricated (or 'synthetic') harbour. In fact, bring two – Mulberry A and Mulberry B.

And as the plan was considered, so the benefits made it the obvious choice, not least because even the earliest stages of construction would provide shelter for the smaller landing craft – no such thing as an HMS Bulwark or RFA Cardigan Bay in those days – that would eventually ferry ashore two-thirds of the material required by the Battle of Normandy.

But the final installation would have to be a well-built, integrated piece of kit, as one of the main requirements was that it should survive a half-gale and should be able to stand the wear-and-tear of at least 90 days of use – the planners of Operation Neptune built into their calculations the expectation that Cherbourg would be in Allied hands within three weeks.

The first consideration of planners was how to provide sheltered water for unloading ships, with five serious contenders:

- 1 Blockships;
- 2 Concrete caissons sunk in line;
- 3 A floating breakwater of specially-built pontoons;
- 4 A floating breakwater of moored Liberty ships;
- 5 A 'bubble breakwater', where wave motion is suppressed by a curtain of air bubbles generated on the sea bed.

The last two were swiftly dropped, but the first three went on to become parts of the Mulberries.

With little time in hand, as the plan started to slowly take shape, design work, trials and construction began almost simultaneously and ran in parallel.

And while it meant there was hardly any time for trial and error – problems had to be eradicated as the project progressed – it created an atmosphere in which almost anything would be considered, and the most imaginative idea often produced the best results.

This approach was encapsulated by Winston Churchill himself, who was pondering the problems of beach landings as early as May 1942, when in a famous note to the Chief of Combined Operations he wrote:

"Piers for use on beaches: They must float up and down with the tide; the anchoring problem must be mastered. Let me have the best solution worked out. Don't argue the matter. The difficulties will argue for themselves."

As the plan matured, so the basic elements of the Mulberries took shape and acquired names.

The first to be installed would be the **Gooseberry** – an instant

breakwater of blockships that would provide shelter for the small landing craft and launches.

Operation Neptune called for a **Gooseberry** to be built for each beach by D+3, and for **Gooseberries 2 and 3** (at St Laurent/Omaha Beach and Arromanches/Gold Beach) to "grow into **Mulberries** – no mean horticultural feat," according to *The Story of the Mulberries*, the official 1947 War Office account of the project.

**Gooseberries** were themselves composed of between nine to 12 ships sunk at around the two-fathom line, and were the responsibility of the Royal Navy.

Although, as the War Office noted, blockships were normally used to close harbours rather than create new ones, the Navy had been dealing with such vessels for hundreds of years.

The requirement for 60 self-propelled vessels, at a time when the Battle of the Atlantic was still raging, was a tall order, but the risk of an Allied landing failing for the sake of these ships meant the resources were found – 31 from the British Ministry of War Transport ("mostly old crocks", according to the War Office account), 22 from the Americans and the remainder a jumble of worn-out Allied warships.

These ships – **Corncocks** in Op Neptune terminology – had the advantage of not requiring valuable tugs (which would be needed to tow other parts of the Mulberries across the Channel) and their deckhouses and superstructures would provide some accommodation for the crews of small craft sheltering in their lee.

They did, however, need to be sunk in precise, overlapping locations, preventing the sea from scouring between and below them.

As these **Corncocks** had to be prepared for their role, fitted with explosive charges and wired up, their purpose would be obvious to workers and crews. The men had to be sworn to secrecy, and the ships were fitted out and berthed in isolated lochs and anchorages off the west of Scotland in the months before D-Day.

Such ships would only do part of the job required. With a large tidal range – around 23ft – a more tailored solution was required, and that came in the form of **Bombardons** and **Phoenixes**.

The concept of **Bombardons** reportedly came to the mind of Lt Cdr Robert Lochner RNVR one hot Sunday afternoon as he relaxed beside a swimming pool.

Through half-closed eyes he noticed how the wavelets on the windward side of a lilo air mattress were damped down to almost nothing on the leeward side.

After some thought and discussion, three giant lilos were constructed – quite a task for Dunlop Rubber, as they were

## Main components of Mulberry harbours:

- 1 Whale flexible roadway
- 2 Phoenix breakwater caisson
- 3 Bombardon floating breakwater
- 4 Beetle floating roadway link
- 5 Spud pierhead

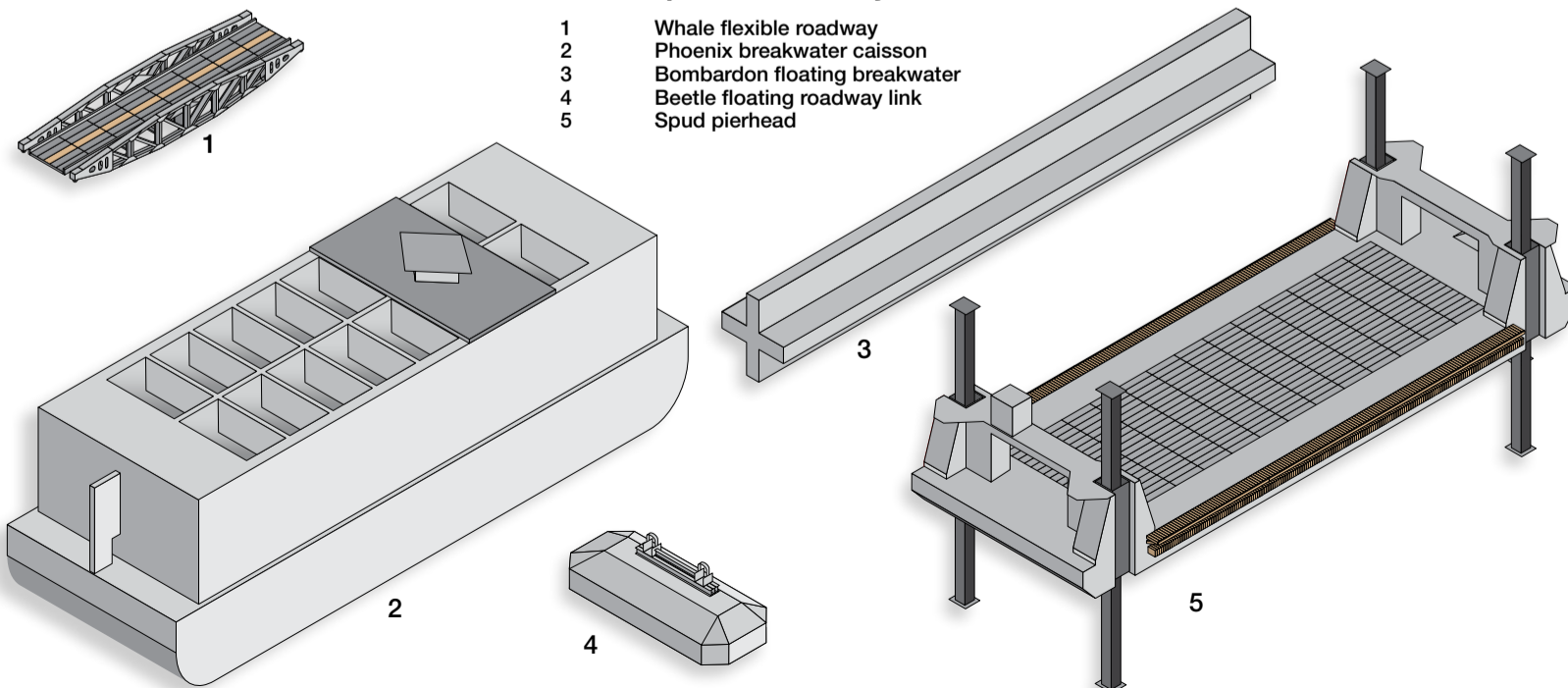



# ? Grow your own...

200ft long, 20ft in diameter and each had a 750-ton concrete keel – and they proved successful in tests, though the final design used steel as rubber was too easily damaged.

Bombardons were designed and built by the Royal Navy – 200ft long with a hollow cruciform cross-section in which the lower sections were filled with water, the air-filled top ‘fin’ maintaining buoyancy.

Designed to move at a slower rate than waves and thus blunt the energy of the worst weather expected – a half gale, with 150ft between wave crests – a string of 20 of these 2,000-ton devices, linked by heavy manila ropes, would theoretically form a mile-long breakwater, providing calmer water for the bigger ships to anchor and affording some protection for the Mulberries themselves.

Phoenix was an all together more sturdy feature, and these reinforced concrete caissons – the responsibility of the Army – were needed as Liberty ships required at least 30ft of depth at low water.

When the tides were taken into consideration, each Phoenix would need to be at least 60ft high to provide a seaward breakwater for the activities within the Mulberry.

This simple concept required huge amounts of concrete, numerous sites to build them and they had to be sufficiently seaworthy to make a Channel crossing behind a tug.

Compromises were called for – to fulfil their function when ‘planted’ off the Normandy beaches each caisson should have had square ends to prevent tidal scouring through any gaps, but to enable a tow to take place this had to be changed to a slanted ‘swim’.

They also had to be solid enough to withstand months of battering from the sea, but simple and light enough to be built quickly in the required time frame, minimising the use of valuable steel.

As the War Office noted: “With so little previous experience it would not have been unreasonable, even under wartime conditions, to take some three months in the research and design stage before the blueprints came off the drawing board; thereafter, normally some six weeks or two months might well be fully taken up in developing practical construction details and getting out contracts.

“But in this case we could not afford three, let alone five, months before construction started and the whole of the above stages were telescoped into a period of 14 days.”

A group of top engineers, leading contractors and Allied military experts was formed which met almost continuously for two weeks, at the end of which they emerged with the design for Phoenix, which came in six sizes (depending on the depth of water in which they were to sit), ranging from the giant 6,000-ton A1s to the 1,600-ton D1s.

The first practical problem was where to build them. The final numbers had not then been decided, but when rough estimates came through the initial requirement was for 147



● A Beetle concrete float is launched, probably at Weymouth in Dorset or Marchwood on Southampton Water

Picture: © IWM (A 25810)

by D-Day, ultimately rising to 213.

A rapid survey of all available dry docks, from the Tyne right round England and Wales to the Mersey – all of which also had vital repair and building work to undertake – meant that there was only sufficient capacity to build half of the Phoenixes required.

The obvious answer – build more dry docks – would take too long, but it set planners on a line of thought which resulted in a series of shallow ‘scraped out’ basins along the Thames and other suitable estuaries close to wharves.

One such example, operated by Arthur Monk and Co, saw men dig out a basin with an earth-bank coffer dam at Barking Creek.

A thin binding layer of concrete was poured, after which levels of concrete were built up with softwood soffit boards until the Phoenix ‘hull’ was complete.

Work at Barking was officially from 8am to 6pm, but often the teams remained on site until late to ensure the job was done properly – the concrete was pumped in and had to be of good enough quality to ensure the Phoenix was watertight.

Indeed, work sometimes continued through the night using floodlights, which had to be extinguished if the air-raid sirens wailed.

In the case of Phoenixes built at Barking Creek, once the lower sections of each was completed the bund was broken to allow it to be floated out and towed upstream to East India Docks for completion while the next one was started at Barking.

That scheme brought its own problems – a Phoenix was designed to cope with the stresses of floating when fully-built, so the unfinished ‘hulls’ had to be additionally strengthened and lightened in specific areas to prevent cracking, or ballasted to counteract ‘hogging’ (sagging at the ends). Some rapid recalculations were required...

And when the total number of Phoenixes was established, it could be worked out that up to 1,000,000 tons of concrete,

70,000 tons of steel and 1.5 million square yards of shuttering would be required, a task that was undertaken by 25 main contractors using at least 23,000 workmen of various trades across 40-50 sites.

Labour was also a headache, and it eventually proved necessary to draft in workers from Southern Ireland, which itself caused friction as civvies worked alongside the military, with widely-varying rates of pay and conditions.

Work began on October 30 1943 and the initial 147 units were all delivered by May 27 1944 – ten days before deadline. The first A1 units took four months to complete, but once teething troubles had been eradicated the rate of production doubled to two months each.

At the heart of the Mulberry harbour was the Whale dock system which comprised Spud pierheads, flexible floating roadways and Beetle pontoons – and here the Allies were fortunate in that the principles had been under consideration for two years.

A prototype had been successfully tested during the summer of 1943, which meant that the plan only needed to be tweaked to allow its use at Arramanches and St Laurent.

The Spud was a 1,000-ton pontoon 200ft long and 60ft wide resting on four steel legs. A diesel-driven generator provided the power for four electric motors to raise and lower the platform on the legs, and as they were independent each leg could be adjusted differently to allow for variations in the surface of the sea bed.

With the legs up the Spuds could be towed across the Channel, and when in position the motors maintained the pontoons at a steady height above sea level as the tides rose and fell.

Strung together with 90ft ‘dumb’ pontoons, a row of Spuds formed a stores and disembarkation quay, and Spuds at right-angles to the main line allowed Landing Ships (Tank) and larger landing craft to discharge cargo and

vehicles through their ramps onto artificial concrete sloping beaches. LSTs could also unload through a high-level ramp and drawbridge.

The floating roads were the answer to the trickiest problem, which was ensuring unloading could happen anything up to a mile offshore and vehicles flow to the beach during bad weather as well as good.

The system was based on standard 80ft lengths of roadways, hinged, braced and linked in such a way that it was flexible enough to cope with waves but damped to prevent violent motion on the road surface.

A prototype – the brainchild of engineer Allan Beckett – was built by Braithwaites in West Bromwich and tested at Cairn Head in Scotland; it was eventually chosen partly because it continued to function as planned during storms which destroyed two alternative designs.

Telescopic spans meant the roadways could be used as the tide rose and fell, and if a steel Beetle – the pontoon which linked spans as well as keeping them afloat – was damaged it was a fairly simple process of installing two Camels (temporary inflatable rubber pontoons) either side of the Beetle before replacing it.

Beetles (the design of which derived from the carapace of the turtle) were moored in place by 600ft cables and highly-effective anchors, and to avoid damage on the rocky foreshore the shoreward Beetles were fitted with four legs (like mini-Spuds) which could be hand-winch down to take the load as the tide dropped.

To save valuable steel, those Beetles that remained afloat even at low tide were manufactured from concrete.

Numerous factories were involved in building parts for the Mulberries – some 250 for the Whale pier assemblies alone – which were assembled into larger units or finished items.

But at some point, not too long before the proposed D-Day, all the elements had to be gathered together at convenient harbours and anchorages before the Channel crossing.

This in itself was a massive logistical operation, requiring more than 600 separate tows

● (Left) Spud pierheads at anchor off Selsey Bill in the weeks before D-Day

Picture: © IWM (A 24116)

● (Right) A massive Conundrum, used to hold pipes for the PLUTO project

Picture: © IWM (T 00030)

from around the British coast – a task which fully occupied 200 tugs for three months.

The job was fortunately aided by abnormally fine weather, as it was only just completed in time to allow the tugs to be serviced and prepared for the assault tows.

The assembly tows and the tow across the Channel were both the responsibility of the Royal Navy under Operation Neptune – and it was not a task that Jack particularly relished.

The Army’s ‘monstrosities’ – Phoenix development was an Army responsibility – were not easy to handle, and they had to be stored out of the main channels and away from the bustling jetties and wharves in ports and harbours jam-packed with warships, landing craft and freighters.

By D-1, the Mulberries were ready to travel; the Bombardons were at Portland, the Corncocks at Poole, the Whales at Peel Bank near Fishbourne on the Isle of Wight, and the Phoenixes and Spuds at Selsey and Dungeness, with spare Whales and Phoenixes at Dungeness and on the Thames.

The biggest problem by then was the Phoenixes – it is difficult to conceal 6,000-ton blocks from the enemy.

The best solution was to submerge them – they were, after all, designed to sink, and it would protect them from both weather and prying eyes.

This plan relied on the timely raising of the caissons to allow their despatch to France, and a mishap provided a timely warning to Allied commanders.

The plan called for the raising of eight to ten Phoenixes each day to be towed across the Channel, but it was only when one broke loose some time before D-Day and grounded on the Brambles sandbank in the Solent that the scale of such an enterprise became apparent.

It took a salvage tug a week to pump the Phoenix out and tow it off the sea bed, which resulted in the entire Admiralty Salvage Department being called upon to complete the task.

Another major benefit of sinking the caissons was that it provided valuable training for the operators before they planted them for real off Normandy.

One final piece of the Mulberry jigsaw was perhaps the most important of all, and its success meant that the first the Axis powers knew of the existence of these massive artificial harbours was when they were built and in use in Northern France.

Security for the various elements of the build was vested in a number of organisations, including the Admiralty, the War Office and MI5.

Two chief considerations were the physical security of the components, and perhaps more importantly, hiding the true purpose of the programme.

Some elements, such as the Whales, were not a problem – metal girders built at factories across the country gave nothing away.

Spud construction was mainly

carried out at Marchwood near Southampton – a military port manned by Royal Engineers which allowed for tight security.

Elsewhere, it was quickly accepted that no amount of camouflage and physical security would hide huge concrete blocks, as they were being built or towed along the coast, so subterfuge was the only alternative – and history shows it to have been a huge success.

No special passes or measures were required at construction sites, which meant that the caissons were not flagged up as being of particular interest.

Options such as putting fake guns or aerial masts and wires on them to fool onlookers could not be carried out because of shortages of materials and labour.

Instead, the ability of Joe Public to come up with plausible explanations – in this case troop, ammunition or petrol carriers, floating forts or even a floating airfield or pontoon bridge across the Channel – was encouraged, and the fact most Phoenixes were parked around the south-east corner of England helped strengthen the deception cover plan that they were defensive installations against V-weapons or other diabolical secret devices.

It is a tribute to the thousands of men who built the Mulberries, sailed them to their final destination and built the harbours that with only one or two exceptions the plans remained hidden from the Germans.

The bottom line of the Mulberry project was that it cost some £25 million, with Phoenix weighing in at some £9 million, Whale £7 million and Bombardon £1.25 million – collectively well over a billion pounds at today’s prices.

And although theorists, with the benefit of hindsight, suggest the Mulberries were over-engineered, and a smaller scheme could have sufficed (as proved by the success of just one Mulberry after its twin was wrecked), this could only be proven after the event.

Failure to take a port, or a long spell of bad weather, could have scuppered Overlord, and the Mulberries were valuable insurance to Eisenhower and his commanders.

One other engineering marvel which also caused the Royal Navy some headaches was PLUTO, the Pipe Line Under The Ocean.

Massive drums – Conundrums – were designed to carry lengths of pipe which would supply fuel to the Overlord campaign directly from the UK.

And while history shows that tankers using captured ports supplemented the output of PLUTO, it was another guarantee to commanders that their drive into France would not be halted by a military setback, as the flow of fuel through the pipes would keep the engines running.

As it happened PLUTO did not go into operation until August 1944, but the Normandy link, and a similar later version from Dungeness to Boulogne, carried more than 170 million gallons by July 1945.

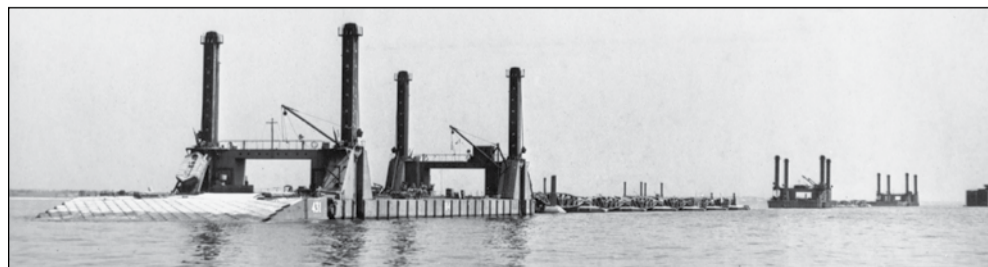

● (Left) Spud pierheads at anchor off Selsey Bill in the weeks before D-Day

Picture: © IWM (A 24116)

● (Right) A massive Conundrum, used to hold pipes for the PLUTO project

Picture: © IWM (T 00030)

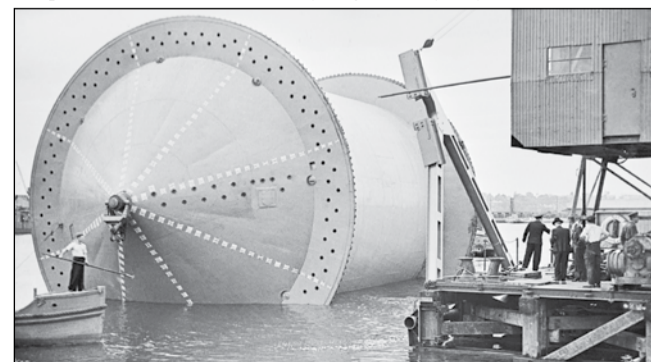



# The guessing game

BEFORE you erect a building, it would be eminently sensible to carry out a survey of the land on which you wish to build.

So before you erect a building upon which the success of a battle – and possibly even a war – depended, you would presumably carry out a thorough survey.

Or you could base your calculations on photographs snatched by low-flying aircraft, ground samples stolen from under the nose of the enemy at night, and picture postcards sent in by happy holidaymakers from before the war.

Although such cards and holiday snaps revealed details of the beaches at resorts along the Normandy coast, it all smacked of desperation.

In fact, as the plan for Operation Neptune took shape, the various clandestine efforts to gather data proved highly effective – and with hindsight turned out to be remarkably accurate.

Allied pilots flew numerous sorties to photograph the Normandy beaches from overhead and oblique angles, at all states of the tide, in calm and rough weather and at various times of the day.

Such pictures allowed planners to make deductions about such things as the profile of the beaches and the depth of the sea below the low-water mark, but they could not help with the shape and composition of the beaches, the hinterland and the sea bed.

The most recent French Survey charts were over a century old, dating back to 1836, and the landing and bombardment areas were not well-used shipping lanes.

To fill in the vital gaps, secret surveys were carried out at night.

Typically, a buoy would be placed in the middle of the area to be surveyed and a baseline – a taut wire – was run ashore to check the accuracy of the position of the buoy.

Once that base was established, a series of soundings could be carried out along lines radiating from the buoy.

The composition of land and sea bed was ascertained by two-man parties from the Combined Operations Pilotage Parties (COPP), who would swim ashore from midget submarines or specially-adapted landing craft and take core samples using tubes similar to those used to cut holes on golf courses.

One such survey took place on Gold beach as the Germans prepared to celebrate New Year 1944, with two Army men, Maj Logan Scott-Bowden RE and Sgt Bruce Ogden-Smith being asked to repeat their dangerous but vital work for the American beaches in January 1944.

Although the unit numbered fewer than 200 volunteers, they collectively won 90 medals and commendations in just three years. And reportedly just one such venture was discovered by the enemy – in the Pas de Calais on May 17-18 1944, which actually added weight to the deception that the area would bear the brunt of the allied invasion.

By having such samples analysed, commanders could be sure that the beaches would support the weight of tanks and other armoured vehicles.

Other observations could also be made of the beach at the same time, including the extensive tidal surveys which had to be carried out to ensure landing craft coxswains were not swept off course and the Mulberry harbours could be placed to maximum effect – the tides in that part of the coast were particularly

high and fast-moving.

The War Office account of the Mulberry harbours summed up the quandary in which planners found themselves when committing themselves to paper – not just for the artificial harbours, but for the whole of Operation Neptune.

“[Planners] found themselves in much the same case as a schoolboy sitting an examination for which he has been inadequately coached but in which his success may well ensure the future security of his family.

“The earlier questions seemed fairly simple; next come a series which, he feels, he ought to get right unless there is a catch in them, as some appear to have; lastly there are a few really formidable posers to which he has hardly a clue.

“The golden rule is, of course, to write something in answer to each because if you write nothing you will certainly get no marks.

“You have to guess; the important thing is to make the guesses as intelligent as possible; but in the case of the planners it is almost more important to get your guesses agreed by all concerned, so that all will work to a common end and thus turn what may have started as an indifferent guess into, at least, a workable solution.

“The more timid souls took some convincing in this respect and it is not too trite to say that planning under these circumstances requires as much courage and stamina, albeit of a different category, as does more active war employment.”

Much the same could be said of the thankless task of the weather forecasters, who provided the most crucial input into the final decision to launch the Normandy landings.

Churchill opined, in the House of Commons on D-Day itself, that Operation Neptune was “the most complicated and most difficult [operation] that has ever taken place.

“It involved tides, winds, waves, visibility, both from the air and sea standpoint, and the combined employment of land, air and sea forces in the highest degree of intimacy and in contact with conditions which could not and cannot be fully foreseen.”

With all other (manageable) factors addressed, the last remaining great unknown was the weather – and the requirements were exacting.

The assault needed a moonlit night, a low tide as dawn broke, light winds and little by the way of low cloud throughout the day and for several following days.

From that wish list a set of

minimum weather conditions was established:

❶ D-Day should be within one day before, to four days after, a full moon;

❷ D-Day should be ‘quiet’ (wind less than Force 3 onshore and 4 offshore), immediately followed by at least three quiet days;

❸ Cloud cover of less than 30 per cent below 8,000ft and visibility of more than three miles.

Working from astronomical and tide tables, the optimum dates for D-Day would be June 5, 6 and 7; the tide was right again two weeks later, but not the moonlight.

The Met Office has calculated the odds against the wind and weather being even broadly acceptable as 13 to 1 against.

Factor in the need for the right conditions to identify beach mines and obstacles at sunrise – and the odds just about trebled.

And the full moon, to help airborne forces’ pre-dawn landings, doubled the odds again.

Weather forecasts for seven days ahead became a critical element of Eisenhower’s routine in the months before D-Day, though such forecasts during the war were clouded by uncertainty.

As spring developed into summer – May 1944 was generally a period of settled, hot weather in the South – three teams of forecasters pooled their expertise under the leadership of the experienced Gp Capt James Stagg, an eminent civilian forecaster who in 1943 had been commissioned into the RAF Volunteer Reserve and appointed the chief meteorological officer for Operation Overlord.

Through secure telephone conferences, the Met Office, Royal Navy (led by Instructor Cdr John Fleming, meteorologist to the Naval Commander-in-Chief Allied Expeditionary Force) and US Army Air Force predicted the days ahead. Stagg presented the consensus – ‘agreed forecasts’ – to Eisenhower and his commanders for assessment.

May’s settled weather broke at the beginning of June, bringing unseasonal westerly winds, low pressure systems and weather fronts from the Atlantic.

Such unsettled, unpredictable weather caused divisions between the experts, though at 9.30pm on Saturday June 3 they had reached agreement.

Stagg had the unenviable task of standing before Ike and his team to say the weather was expected to be too bad – strong winds, cloud and rough Channel seas – for landings on June 5.

Stagg appreciated that the machinery of Operation Neptune was already in motion – some

troops and equipment were being embarked on their ships and landing craft and the furthest-flung squadrons of escorts and towing tugs had already begun their progress to assembly points.

Delays also gave the enemy a greater chance of discovering the preparations.

But that evening, as the sun shone into the windows of Southwick House on Portsdown Hill north of Portsmouth, Eisenhower decided to “hold up Operation Neptune on a day-to-day basis”.

That was confirmed the following morning as the first signs of bad weather confirmed the forecasters’ fears.

By the evening there was driving rain and gusty winds across Hampshire – but the 9.30pm conference brought unexpected advice.



● Dummy landing craft used as decoys in harbours and creeks in south-east England  
Picture: © IWM (A 42527)

## Bodyguard of lies protected Neptune

DECEPTION is one of the oldest military tactics in the book – look no further than the legend of the Trojan Horse, dating from thousands of years ago.

The beauty of a well-crafted ruse is that for relatively little outlay a great deal can be achieved.

Churchill was a firm believer in subterfuge, observing: “In wartime, truth is so precious that she should always be attended by a bodyguard of lies.”

Stagg and his experts realised that the cold front bringing the foul weather which had enveloped Portsmouth had arrived earlier than expected and would clear the area of operations within a matter of hours.

Behind it was a ridge of high pressure expected to bring a period of relative calm for the critical hours of Tuesday June 6.

Strong winds – too strong for the frail landing craft to cross the Channel – were now expected to moderate throughout Monday, providing suitable weather for the airborne invasion as well as the first wave of the amphibious assault during Monday night and Tuesday morning.

Stagg was confident in that window of opportunity, and reported that there was a chance the high pressure would last longer than Tuesday – but he

could not predict the weather for Wednesday June 7 onwards with any confidence.

Indeed, when Eisenhower asked how many hours he could count on for the attack on June 6, Stagg replied that the morning would be fair and good weather might last throughout the afternoon. He could say no more.

Eisenhower consulted his chiefs, and Field Marshal Montgomery summed up the mood: “I would say ‘Go!’”

With anxious troops crammed into vessels large and small, warships loitering and aircraft sitting at dispersal points across the South of England, the moment had finally arrived.

Eisenhower set Operation Neptune – and therefore Operation Overlord – in train.

And although it was not apparent as the room cleared and orders winged their way across the Allied armada, the decision to go prevented what may have been a military catastrophe.

For the next available window of opportunity, two weeks later, brought an unexpected and ferocious storm which could have wrecked Neptune before the first troops set foot in France.

Ironically, the Germans did not have access to the data which was made available to Stagg and his team – Axis weather ships and U-boat reports in the Atlantic were being culled at a rapid rate.

The slim chance of fair weather spotted by Allied forecasters might also have given the Germans a warning – but their limited capabilities meant that the poor weather of June 5 was expected to continue – and as the Allies would surely not set out for an invasion in such an unsettled period, the defenders relaxed.

Tommy would not come just yet, they told themselves...



● Commandos practise assault tactics at the Combined Operations School, Dundonald Camp  
Picture: © IWM (A 14350)



## Always on the move...

THE DEPLOYMENT and roles of units was a closely-guarded secret in the months before Operation Neptune finally swung into action – but anyone trying to discern a pattern would have been sorely tested.

Take the example of L/Tel Alan Winstanley, whose build-up to the landings began in the first weeks of 1944.

Arriving at HMS Mercury near Petersfield, he and his colleagues stowed their Naval kit and were issued with khaki, then trained in Army fashion – assault courses, unarmed combat and the like (the only benefit being that route marches tended to finish at the Bat and Ball pub at Broadhalfpenny Down near Hambledon in Hampshire, one of the most hallowed grounds in cricket).

Alan was not too keen when he was attached to No1 Light Mobile Bombardment Patrol Unit at Southwick Park (“too much bull there”) so he managed to get a transfer to No1 Heavy Mobile Bombardment Control Unit, headed by a Royal Marines captain.

“We were a mixed bag of RN and RM personnel, and went on various exercises from Funtington Hall, never sure what they were all about,” said Alan.

“Finally left Funtington after being issued with 0.33 Smith and Wesson revolvers plus ammo.

“Spent a few more weeks roaming around the South Coast, finally to Southampton Common.

“Then across country to Ipswich where we spent three weeks in a sealed camp.

“Saturday June 3, struck camp and embarked on an LCT in the River Orwell.

“We should have sailed on the Sunday for Gold Beach but weather delayed sailing for 24 hours, so when we landed on June 6 we had spent three days on the LCT.

“The trip down the east coast and up the Channel was mainly uneventful, although most of the Army personnel on board were not ‘over happy’ with the choppy sea and the rolling and pitching of the LCT.”

## Furniture to fighters

THE extraordinary measures required to stage an assault on the scale of Operation Neptune, and to take the fight to the Fatherland were demonstrated in the contribution by furniture manufacturer Harris Lebus.

Based in the East End of London, Harris Lebus was a well-known name in furniture during the first half of the 20th century.

The skills of its craftsmen and the scale of production – the firm employed over 1,000 people even before it built a new factory in Tottenham in 1900 – made it an ideal partner for the military.

It had made munitions, wooden items and, from 1917, much of the Handley-Page O/100 bomber, during World War 1.

And the firm was again called on to help the Allied cause in World War 2.

Beside their core business of furniture, Harris Lebus produced large numbers of LCAs – the workhorse landing craft of Allied amphibious forces before, during and after D-Day.

They also built the Airspeed Horsa glider, used extensively in the Overlord airborne assault, and the hugely-impressive de Havilland Mosquito fighter-bomber.

Not forgetting a useful sideline in dummy landing craft and plywood tanks for deception purposes...



● American troops marching along the Esplanade at Weymouth on their way to the docks where they will be loaded into landing craft for the assault on Normandy  
Picture: US National Archives photo no C727

# Assault forces head south

AS ENORMOUS efforts went into creating the ships, aircraft and Mulberry Harbours required to initiate and sustain the Normandy Landings, the preparations for Operation Neptune had a profound effect on the landscape of Britain – some of it temporary, some of it permanent.

The southern part of Britain was a vast marshalling area for the initial invasion force, split between the Eastern force (roughly east of Bournemouth, as far as Suffolk) and the Western, which included South Wales.

The eastern sector mainly – but not exclusively – dealt with British and Canadian troops destined for Sword, Gold and Juno beaches.

Hampshire, for example, hosted three main marshalling areas: Area A was around Portsmouth and as far north as Petersfield, Area B covered the New Forest and Area C was around Southampton.

The creation of these ‘sausage factories’ – so-called because of their shapes on maps – saw vast tented camps created in woodland and countryside, mostly camouflaged from the air by trees and shrubbery by now in full leaf, with Southampton Common hosting one of the larger camps.

‘Sausage camps’ also referred to the practice of putting a string of smaller holding camps, containing up to 230 men, along a stretch of road where they could be hidden by hedgerows and the like – the main holding camps could be as large as 9,000 men.

Each marshalling camp had its own infrastructure in terms of feeding, maintenance and planning, and each had a concrete tank or dammed stream nearby to test waterproofing of equipment.

Roads between the camps and the coast became huge parking areas for tanks and other vehicles required for Overlord.

New Naval units sprang up on creeks and small harbours to train and support Neptune and other landings (including Operation Torch in North

Africa) – Mastodon at Beaulieu, Sea Serpent near Chichester, Newt in Newhaven, Squid in Southampton and so on.

Billets had to be found for thousands of military staff – Anthony Kemp, in his book *Springboard for Overlord – Hampshire and the D-Day Landings* states that almost 30,000 extra billets had to be found in Portsmouth alone for Overlord and Neptune staff, and hotels, guest houses, schools, public buildings and warehouses were commandeered in ports along the South Coast to accommodate these extra staff.

Labourers and workforces also had to be accommodated, including those working on the creation of Mulberry components. New equipment had to be manufactured and tested, such as the PLUTO project.

The prototype pipeline was produced in Portsmouth Dockyard (production then moved on to Tilbury in Essex) and dry-runs saw lengths of pipe put into the sea off Bournemouth before a cross-Solent pipe was laid to Gurnard on the Isle of Wight.

Terminals for the Overlord cross-Channel PLUTO were created at Sandown and Shanklin.

Beaches in Hampshire had been placed under restrictions from as early as 1940, and by 1943 certain beaches such as Southsea were closed completely and residents moved away to allow training for D-Day to proceed unimpeded.

On April 1 1944 the government banned all visits to within ten miles of the British coast where troops were gathering.

Briefings in marshalling camps began on May 22, using models, charts and photographs of the Normandy coast – and at this point the troops became completely isolated from the outside world to preserve the element of surprise which was vital to the success of Neptune.

Air operations also impinged on civilian lives – one Portsmouth evacuee, who moved to the tiny village of Sherborne St John near Basingstoke, recalled seeing a glider stuck in a field, and the



● Churchill Mk IV tanks on the Winchester by-pass in Hampshire on May 16 1944  
Picture: © IWM H 38510

attempts to recover it using a slow and low-flying tug which hooked a loop on the glider at the second attempt and flew away.

It was the same pattern – though with an American accent – in the West Country, with marshalling areas appearing near towns and cities including Truro, Plymouth, St Austell, Torquay, Dorchester, Bristol, Cardiff and Swansea.

By this point the Cunard liners RMS Queen Elizabeth and Queen Mary – the ‘Monsters’, now converted to troopships – were bringing up to 16,000 soldiers at a time across the Atlantic, relying on their high speed to evade U-boats.

Gathering the troops and equipment was one thing, but getting them embarked into thousands of vessels was another.

Existing ports could not handle the volume of traffic generated by Operation Neptune, so other arrangements had to be made.

Railway companies built new spur lines and marshalling areas near embarkation points, and some of the marshalling areas also served as transit camps for those joining their ships.

Suitable jetties, such as Portsmouth Harbour station and South Parade Pier in Southsea, became temporary embarkation points, and other new jetties and

pontoons were built in ports, creeks and estuaries, but even this would not be sufficient.

The fact that troops would go ashore using landing ramps went a long way towards solving the problem – they could be loaded just as easily using the same ramp.

So gangs of constructors roved the coasts laying concrete aprons – hardstandings or ‘hards’ – from roads to the water’s edge in sheltered locations, over which soldiers could board their craft without getting their feet wet.



● Troops of the 6th Airborne Division get Allied-produced French currency before they embark  
Picture: © IWM (H 39081)

## Leaders gather at village

THE impact of the gathering invasion force on communities in the south of England is hard to imagine in the 21st Century.

One such community was the tiny Hampshire village of Droxford, in the picturesque Meon Valley.

All around southern Hampshire camouflaged camps and military depots had sprung up to accommodate troops and their equipment within easy reach of embarkation points on the Channel coast.

But Droxford was just ten miles from Southwick House on the northern slopes of Portsdown Hill, the headquarters of the main Allied commanders in the weeks before the Operation Neptune invasion fleet set sail.

And when a secret, secure location was required for a meeting of those Allied leaders in early June 1944 to discuss the final details of Neptune, Droxford was deemed ideal.

Just on the edge of the village – which today has a population of a shade over 600 – lay a station on the rural Meon Valley Line between Alton and Fareham.

Close to this station, more used to dealing with farm produce and livestock than military strategy, was a deep cutting and extensive siding – as well as a tunnel a little further down the track – providing a degree of protection from air raids.

Thus it was that on June 2 1944 a special train of eight carriages – codenamed Rugged – pulled into Droxford, and on to the platform stepped Winston Churchill.

Shortly after, Churchill met with Free French leader Charles de Gaulle and other senior Allied figures, including South African Prime Minister Jan Smuts, a senior member of the Imperial War Cabinet, to discuss the plans for Operation Neptune.

The men later went on to meet with Gen Dwight D Eisenhower – but that marked the end of Droxford’s brief spell in the limelight of world history.

Within two days Operation Neptune had become a reality, and the tens of thousands of fighting men and their machinery in the surrounding countryside had melted away, joining the battle to liberate Europe which had flared along the coast of northern France – and leaving Droxford, and a thousand other settlements like it, to return to bucolic peace.

The little village has big plans to mark the 70th anniversary of D-Day.

The programme includes a visit to the D-Day Map Room at Southwick House on Wednesday May 28, a talk entitled ‘Churchill in Droxford’ on Friday May 30, displays and re-enactments on Saturday June 7 and a 1940s-style tea dance at the village hall on Sunday June 8.

For more details see [www.friendsofdroxfordchurch.org.uk](http://www.friendsofdroxfordchurch.org.uk)



Events  
mark  
D-Day 70

VARIOUS communities on both sides of the English Channel are marking the 70th anniversary of D-Day.

Portsmouth City Council, in conjunction with the Royal Navy, has organised five days of events ashore and at sea to reflect the city's crucial role as the springboard and command centre for Operation Neptune, the amphibious landings in Normandy on June 6 1944.

A veterans' village will be set up on Southsea Common on June 3-8 for those who took part in Operation Overlord, the codename for the Allied invasion of France, to meet up.

A drumhead ceremony will be held on the Common on June 5, featuring a parade of veterans, serving personnel and cadets as well as the Royal Marines Band.

Royal Marines commandos will stage a beach landing and the Red Arrows are expected to put in an appearance on the same day.

June 5 concludes in Portsmouth with a 'sunset concert for heroes' by Bournemouth Symphony Orchestra on the Common, and a flotilla of ships, including frigate HMS Richmond, will depart from the naval base for northern France.

Events continue in Portsmouth on June 6 with the annual service of remembrance at the D-Day Stone, close to South Parade Pier, followed by a parade along the seafront past the D-Day Museum to the Common, where people will also be able to watch proceedings beamed live from Normandy on giant TV screens.

June 7-8 will be dedicated to the 'D-Day Experience', when the city will host a variety of entertainment including a vintage market, showings of war films, talks and displays, while a 40s-style concert will conclude on June 7 with a fireworks display.

www.ddaymuseum.co.uk

The Imperial War Museum marks the anniversary of the landings with a special air show at Duxford, in Cambridgeshire, and on board former Royal Navy cruiser HMS Belfast.

The D-Day Anniversary Air Show, on Saturday 24 and Sunday 25 May, will feature types of aircraft seen over the Normandy beaches, including a Dakota and a Seafire.

Belfast, now a museum ship moored on the Thames near Tower Bridge, reportedly fired some of the first shots of the bombardment phase of Operation Neptune.

www.iwm.org.uk

Across the Channel, ceremonies will be held on June 5 to mark the airborne element of Overlord, including events at Pegasus Bridge, the first place in France to be liberated, and a mass parachute drop by 16 Air Assault Brigade to mark the liberation of the village of Ranville.

On June 6 itself a service of remembrance will be held in Bayeux Cathedral, organised by the Royal British Legion, a ceremony at the Commonwealth War Graves Commission cemetery at Bayeux, organised jointly by the Normandy Veterans' Association and the RBL, a march-past and service at Arromanches.

Individual communities and groups are also planning events to coincide with the anniversary, ranging from Droxford in Hampshire (see previous page) to the historic gun battery at Mont Canisy near Bénéville-sur-Mer, which is paying tribute to the Royal Navy's sailors involved in the D-Day bombardment – see French website www.mont-canisy.org

# Rising tension – then a false start

THE weeks and months leading up to June 6 saw a crescendo of activity at land and sea across the UK – followed by an unexpected but enforced hiatus that played on fraying nerves.

Among those preparing was 2nd class stoker F McLean, an 18-year-old sailor billeted in a seafront hotel in Exmouth, Devon – and rather enjoying life.

The only downside? Manning what could only be described as floating bombs.

They were old Thames barges which had been strengthened with nine inches of concrete in their hulls and were powered by two petrol engines, moored in the River Exe before Operation Neptune began.

"No galley, toilets, wireless, just one pocket watch – this, no doubt, is why a lot of these barges sank off the Isle of Wight," said Mr McLean.

"The crew consisted of one leading seaman, cox'n, three seamen and three stokers, and our role was that of a floating petrol station.

"To help us fill this role we had 1,100 gallons of petrol in a large tank forward of the engines, with hundreds of five-gallon drums of engine oil in racks against the bulkheads.

"The armament was one revolver, twin Lewis, no naked lights were allowed and all pumps were manual."

Rehearsing in Weymouth Bay, Mr McLean was on watch so missed out as his shipmates hitched a lift from a passing boat for a run ashore.

"I recall as it went dark an air raid started, and we were ordered out to sea finishing up in Poole Harbour," he said.

"Another leading seaman came aboard to help with the crewing. He told us it was unlikely we would see the rest of the crew again as the hotel where they were billeted for the night had been hit.

"Our entrance to Poole Harbour was memorable, to say the least – we woke everybody hitting other craft in the harbour..."

Another sailor stationed in Dorset was AB Abbott, who worked on the Bombardment sections of the Mulberry harbours.

"We were stationed at HMS Shrapnel in Southampton while parts of the harbour were being built," recalled Mr Abbott.

"When it was finished we took it down to Weymouth. When we went aboard a Yankee ship, the Yanks called it a 'floating coffin'."

After mooring their 'floating coffin' he and his shipmates were sent to HMS Attack in Portland, every day for some two months, where they would practise handling the Bombardons.

Preparations did not go



● American troops destined for Omaha beach prepare to sail from Weymouth for Normandy in British landing craft. Tied up in the background are cutters of US Coast Guard Flotilla 10. The picture is taken from Custom House Quay

Picture: US Coast Guard archive

particularly smoothly for gunner S Parker in auxiliary minelayer HMS Southern Prince, which was undergoing work in South Wales.

One shipmate returning from a run ashore in Barry Town had his legs crushed when he walked between railway trucks, and another sailor committed suicide.

The ship moved to Spithead around a month before D-Day and there was no shore leave, with just mail deliveries and collections (by boat) to look forward to.

Round on the East Coast of England, Arthur 'Jinx' Muirhead was a Yeoman of Signals recently moved from destroyers to HMS Bachaquero, a tanker converted to a Landing Ship Tank.

Having spent some weeks at Inverary, working with Army and Navy commandos, in May the ship sailed to Harwich.

"Towards the end of the month we took our turn with many other LSTs in docking on the Hards, the sloped concrete slipways running from the shore right into the water," said Mr Muirhead.

"Here we loaded Sherman tanks and other Army transport and their crews and, if my memory serves me correctly, our capacity was 80 vehicles.

"My recollection of the loading is seeing the long queues of tanks and transport on shore and the din of their engines starting up and the thundering of the tank tracks as they hit our lowered ramp to enter the hold.

"The only hiccup for us during the loading operation was that our ship's cat decided to go AWOL. As she was the bosom companion of our monkey Minnie we knew the latter would pine if the cat did not return.

"Search parties were organised and the moggie was found."

Their next port of call was

Southend, where Mr Muirhead accompanied the CO and Navigating Officer to collect large sealed envelopes, heavily marked 'Top Secret' and in sequence 'To be opened on sailing', 'To be opened D-Day' and so on.

Also in the area was R Fowler, First Lieutenant of Captain-class frigate HMS Halstead from the time the American-built ship was involved in Atlantic convoy duties. Early in 1944 Halstead was transferred to East Coast convoy duties between Sheerness and Grimsby before being drawn into Operation Neptune.

"Our next job was to escort enormous pieces of concrete – later parts of the Mulberry harbours – large reels for PLUTO and small bungalows (floating kitchens) from Sheerness to other parts of the coast," he said.

"One Mulberry lost its tow in a fog and in our search we nearly collided with the thing!"

Mr Fowler recalled that Halstead was off Southend on June 4 when orders came to stand by a special convoy.

"Sealed orders in hand were to be opened forthwith – no leave to be granted," he said.

"The weather at this time was deteriorating rapidly. I managed to get ashore to deliver some papers and walked the length of the pier and along the front at Southend, both of which were completely deserted.

"It was raining hard and a full gale blowing. On returning to the ship I found that the convoy had been delayed 24 hours."

Chief ERA Graham Hiscox had been enjoying the hot May weather by swimming in the River Dart while the 44th LCT Flotilla prepared for Neptune.

The reality was brought home when he and his shipmates were told to remove all their personal

belongings and only carry their paybooks – his brother had been sunk in HMS Repulse, and he did not want to send his belongings home to worry his parents.

Graham sailed on June 3 and he was not sure how far they had got when the weather turned bad: "Many were sick, and conditions were rather grim."

The delay led to a good deal of loitering by flotillas that had already sailed for assembly points, and more dreary, uncomfortable hours in isolation for those who had not yet sailed.

Steaming past some of those ships on D-1 was James Howse, another Chief ERA, this time in destroyer HMS Talybont.

She was due to join the naval bombardment on D-Day, but before that she sped west, "passing endless rows and rows of ships, literally hundreds and hundreds, steaming eastwards."

Almost at Land's End Talybont met up with battleship USS Texas and her escorts, and accompanied them back to the Solent to prepare for the crossing.

Peter Jones, who served on board anti-submarine trawler HMS Ruby, saw the effects of the restrictions imposed as the invasion loomed.

"Immediately prior to D-Day, HMS Ruby was in a huge cluster of ships in Milford Haven Docks," said Mr Jones.

"No one was allowed out for several weeks and the docks were full of supply ships and US freighters and warships.

"The dock basin was littered with large floating cardboard boxes, containing seven days supply in total for men in battle.

"These had been broken into for the cigarettes and tossed overboard – criminal stupidity by thoughtless men.

"As the men were cooped

up and unable to go ashore it seemed to have an odd effect on everyone.

"Some played 'Cowboys and Indians' and chased each other all over the ship, others were model-making as if their lives depended on it or otherwise it was non-stop card games.

"Then at last the orders came..."

Stan Dolman was on board HMS Orion, which had already supported landings in Italy, and which had "sailed up and down the Bristol Channel to lose the day of June 5 when the landings were postponed."

As Orion was loitering to the west, 18-year-old Bill Best was in Captain-class frigate, HMS Ekins, as it steamed from Sheerness through the Strait of Dover.

He watched as fast launches buzzed around her and her convoy, shrouding the ships in thick black smoke as gunfire from German batteries in France threw up great waterspouts.

The frigate added to the smoke, and Bill assumed that this was part of the ruse to make the enemy think the Pas de Calais was the landing area.

Another ship that ran the gauntlet of the Dover Strait was HMS Albatross, a former seaplane carrier converted to a landing craft depot emergency repair ship in early 1944.

Having spent a couple of weeks off Sheerness with no shore leave, there was a two-hour furlough at Southend before they sailed.

"We received a rousing send-off from some hundred or more Southend folk stationed at the shore-end of the pier; they, like us it seemed, sensed that something momentous was about to take place," said Kenneth Smith.

"Our voyage, however, got off to what can best be described as an inauspicious start, as the ship's navigator managed to place our bows squarely on to the Goodwin Sands!"

To make matters worse they also had to fend off an attack by a German Me109 before tugs pulled them clear at high tide and they sailed on, coming under heavy fire from the same batteries that targeted HMS Ekins.

Closer to the main assembly point, Jack Hall was an A/PO in HMS Warspite, earmarked for the bombardment off the Normandy beaches.

"On the afternoon of D-1, as all were waiting to take station for the great assault, Warspite was permitted to steam some of the long lines of landing craft being escorted," said Mr Hall.

"Our ship's company, if not on watch, was mustered at the ship's side to cheer the small craft as we slowly threaded our way between lines of these ships which seemed to stretch from horizon to horizon.

"Too many to count, they were packed with tanks, trucks and soldiers all plumped up with equipment and lifebelts.

"We could tell from the white faces that seasickness had taken its toll, but nevertheless as we steamed slowly past each vessel great cheers of encouragement went back and forth.

"I think those of us in Warspite hoped and prayed that our massive bulk and great guns lent some measure of comfort to these soldiers as they closed the French coast, and that our efforts the following day would indeed save some of their lives."

## These books and sites proved useful...

Supplement compiled by Mike Gray.  
Graphics and maps by Andy Brady.

It is not our intention in these supplements to repeat the material from the anniversary edition carried in *Navy News* in 1994 and 2004 – both are available online, so for comprehensive Order of Battle lists and a narrative history see [www.navynews.co.uk](http://www.navynews.co.uk)

We have used some material submitted by veterans for previous anniversaries for which space could not be found, as their recollections are as valid in 2014 as they were in 1994.

The following books and websites were consulted during the writing of this supplement:

UK Hydrographic Office ([www.ukho.gov.uk](http://www.ukho.gov.uk))

– including detailed information on the Mulberry Harbour project in *The Story of the Mulberries* (Rear Admiral H Hickling and Brig I Mackillop, War Office, 1947)

*The Navy* magazine, Official Organ of the Navy League, 1944 editions

*Assault Landing Craft: Design, Construction and Operations*, by Brian Lavery

Imperial War Museum ([www.iwm.org.uk](http://www.iwm.org.uk)) – Closed until July but resources online

*D-Day Landings* by Sub Lt Brian Carter RNVR, available from Carter Publications, The Stilts, Meadow Lane, Hemingford Abbots PE28 9AR (ISBN 9 781851 830558)

*The Germans in Normandy* by Richard Hargreaves

*D-Day: The Battle for Normandy* by Antony Beevor <http://www.exercisetiger.org.uk/document-archives/>

The US Army Center of Military History ([www.history.army.mil](http://www.history.army.mil))

Naval History & Heritage Command ([www.history.navy.mil](http://www.history.navy.mil))

[www.beckettrankine.com/content/mulberry-harbour-archives-material](http://www.beckettrankine.com/content/mulberry-harbour-archives-material)

*New Civil Engineer* supplement *Mulberry Harbour 1944-1994*

*Springboard for Overlord – Hampshire and the D-Day Landings* by Anthony Kemp

*The D-Day Encyclopaedia* edited by David G Chandler and James Lawton Collins Jr.

D-Day and afterwards – see the June edition of *Navy News*